



KOLBENSCHMIDT



KNOWLEDGEPOOL

**PISTON RINGS FOR
COMBUSTION ENGINES**



TAKING RESPONSIBILITY IN A CHANGING WORLD



RHEINMETALL

MOTORSERVICE GROUP

QUALITY AND SERVICE FROM A SINGLE SOURCE

The Motorservice Group is the sales organisation for the global aftermarket activities of Rheinmetall. It is a leading supplier of engine components for the independent aftermarket. With the premium brands Kolbenschmidt, Pierburg, TRW Engine Components and the brands BF and turbo by Intec, Motorservice offers its trade and repair shop customers a wide and comprehensive range of top-quality products.

RHEINMETALL

TECHNOLOGY FOR FUTURE MOBILITY

As a global supplier to the automotive industry, Rheinmetall's expertise in air supply systems, emission control and pumps and in the development, manufacture and spare parts supply of pistons, engine blocks and engine bearings puts it right at the top of the markets. Product development is carried out in close cooperation with well-known automotive manufacturers.

**CONTENTS****PAGE**

| | |
|---|-----------|
| 1 BASIC PRINCIPLES PISTON RINGS | 5 |
| 1.1 Requirements on piston rings | 5 |
| 1.2 The main tasks of piston rings | 6 |
| 1.3 Types of piston rings | 8 |
| 1.4 Piston ring designations | 18 |
| 1.5 Structure and shape of piston rings | 19 |
| 1.6 Function and properties | 26 |
| 2 INSTALLATION AND SERVICE | 39 |
| 2.1 Assessment of used components | 39 |
| 2.2 Assessment of used pistons | 40 |
| 2.3 Assessment of used cylinder bores | 42 |
| 2.4 Piston and piston ring assembly | 48 |
| 2.5 Commissioning and running in the engine | 55 |
| 2.6 Sealing problems and damage on piston rings | 59 |
| 2.7 Lubrication and oil consumption | 68 |



Edited by:
Motorservice, Technical Market Support

Layout and production:
Motorservice, Marketing

This document must not be reprinted, duplicated or translated in full or in part without our prior written consent or without reference to the source of the material.

All content including pictures and diagrams is subject to alteration. No liability accepted.

Published by:
© MS Motorservice International GmbH

Liability

All information in this brochure has been carefully researched and compiled. Nevertheless, it is possible that errors have occurred, information has been translated incorrectly, information is missing or the details provided have changed in the intervening time. As a result, we are unable to provide any guarantee nor to accept any legal liability for the accuracy, completeness, currency or quality of the information provided. We hereby waive all liability for any damages, whether direct or indirect in nature and whether tangible or intangible, resulting from the use or misuse of information or from incomplete or incorrect information in this brochure, unless proven to be the result of deliberate intent or negligence on our part. Likewise, we shall not be liable for damage arising because the engine reconditioner or mechanic does not have the necessary technical expertise, the required knowledge of, or experience in repairs. The extent to which the technical methods and repair information described here will apply to future engine generations cannot be predicted and must be verified in individual cases by the engineer servicing an engine or the workshop operator.



THE SUBJECT

Piston rings have been around for as long as combustion engines themselves. Nevertheless, among specialists and users there is still a widespread lack of knowledge or an incomplete understanding of piston rings. No other component is so critical when it comes to loss of power and oil consumption. For no other component in the engine is the gap between expectation and capital invested larger than when replacing piston rings.

All too often, the trust placed in piston rings is clouded by the excessively high expectations placed on them. So – against better knowledge – half truths and untruths, incorrect expectations and misconceptions are often rife among repair shops and end consumers. Most of all, however, piston rings suffer from cheap repairs (e.g. reuse of worn interacting sliding parts) and unqualified installation.

THE BROCHURE

In this brochure, we focus on the topic of piston rings from the point of view of the user. We have refrained from going too deeply into design matters and have focused on the practical aspects. Where we do address design and technical matters relating to development, this is to provide additional information or to enable better understanding.

The brochure mainly focuses on piston rings from the fields of passenger cars and utility vehicles. Engines, which were originally designed for vehicle applications, but which are used in ships, locomotives, construction machines and stationary engines, for example, are also covered. In addition to a technical section on the basic principles, the practical section “Installation and service” provides detailed information on the installation and replacement of piston rings, as well as useful related topics such as lubrication, oil consumption and engine running-in.

The foundation for a successful repair and reconditioning is well-founded knowledge of the relationships in the engine. We highlight the things that are necessary to achieve successful repairs, but also what can happen if certain details are not observed.

1 BASIC PRINCIPLES PISTON RINGS

1.1 REQUIREMENTS ON PISTON RINGS

Piston rings for combustion engines must fulfil all requirements for a dynamic linear seal. They must withstand both thermal and chemical influences and also fulfil a number of functions. They should also have the following characteristics:

Functions

- Prevention (sealing) of gas escape from the combustion chamber into the crankcase so that no gas pressure and engine output is lost
- Sealing, i.e. preventing lubricating oil passing from the crankcase into the combustion chamber
- Ensuring a precisely defined lubricant film thickness on the cylinder wall
- Distribution of the lubricating oil on the cylinder wall
- Stabilization of the piston movement (piston rocking) – particularly with cold engines and even larger running clearance of the pistons in the cylinder
- Heat transfer (heat dissipation) from the piston to the cylinder

Characteristics

- Low frictional resistance so that too much engine performance is not lost
- Good resistance and wear resistance to thermomechanical fatigue, chemical attacks and hot corrosion
- The piston ring must not cause excessive wear on the cylinder – otherwise, the service life of the engine is reduced drastically
- Long service life, operational safety and cost effectiveness over the entire operating time



1.2 THE MAIN TASKS OF PISTON RINGS

1.2.1 SEALING AGAINST COMBUSTION GASES

The key task of compression rings is to prevent combustion gases between the piston and cylinder wall from penetrating into the crankcase. On the majority of engines, this is achieved via two compression rings, which combine to form a gas labyrinth.

Piston ring sealing systems in combustion engines are not 100% leak-tight due to the design, so that small quantities of leak gas always enter the crankcase past the piston rings. This is a normal fact, however, which cannot be avoided completely due to the design.

Excessive transfer of hot combustion gases past the pistons and cylinder wall must always be avoided, however. This would result in loss of power, increased heat supply to the components and loss of the lubricating effect. The service life and function of the engine would be called into question by this. The different ring and sealing functions and the resulting blow-by gas emission is dealt with in more detail in the following chapters.

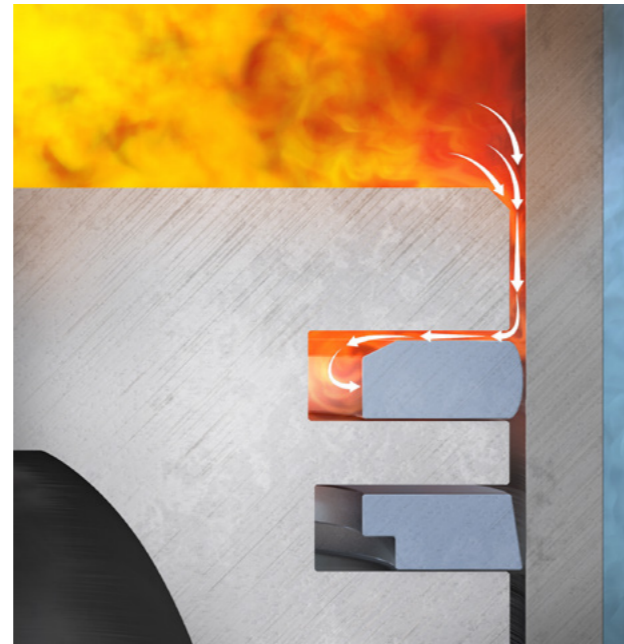

Sealing against combustion gases

1.2.2 SCRAPING OFF AND SPREADING OIL

In addition to the sealing between the crankcase and combustion chamber, piston rings also regulate the oil film. The rings distribute the oil evenly over the cylinder wall. Excess oil is predominantly removed by the oil control ring (3rd ring), but also by combined compression and scraper rings (2nd ring).

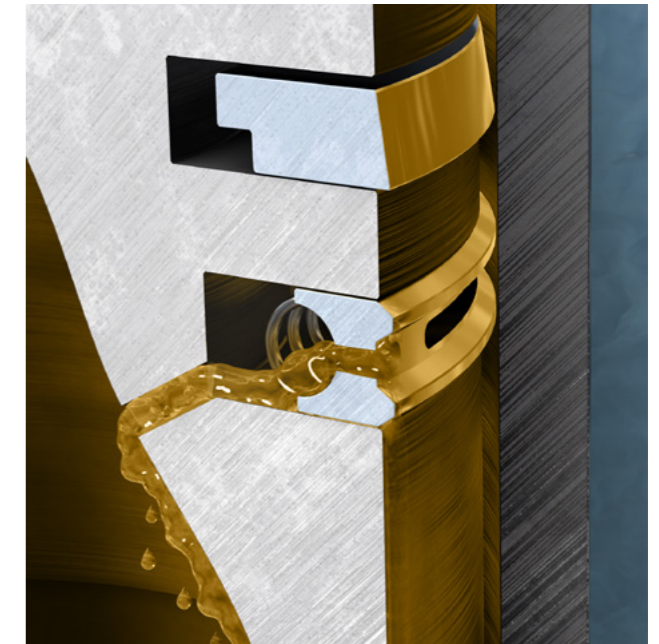

Scrape off and spread oil

1.2.3 HEAT DISSIPATION

Temperature management for the piston is another vital task undertaken by the piston rings. Most of the heat (approx. 70%) that is absorbed by the piston during the combustion process is dissipated by the piston rings to the cylinder. The compression rings in particular play a significant role in the heat dissipation.

Without this continuous heat dissipation of the piston rings, piston seizures would occur in the cylinder bore within a few minutes or the piston could even melt. From this perspective, it is understandable that the piston rings must have good contact with the cylinder wall at all times. If irregularities occur in the cylinder or blockages occur on the piston rings in the ring groove (carbon deposits, dirt, deformation), it is only a matter of time until the lack of heat dissipation causes overheating phenomena on the piston.

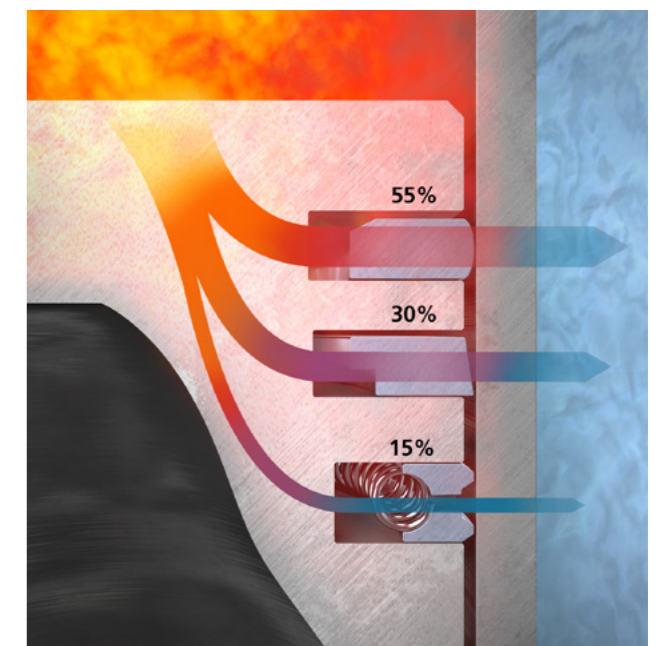

Heat dissipation

1.3 TYPES OF PISTON RINGS

1.3.1 COMPRESSION RINGS

RECTANGULAR RINGS

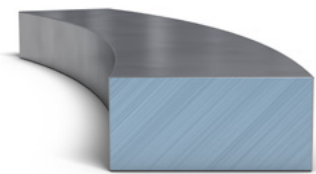

Rectangular ring

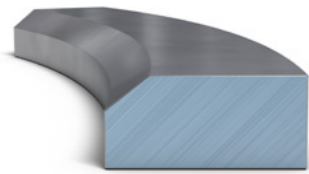

Rectangular ring with inside bevel

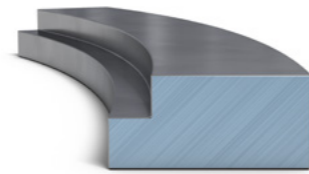

Rectangular ring with inside step



Rectangular ring

The term rectangular ring refers to rings with a rectangular cross section. Both ring sides are parallel to each other. This ring version is the easiest and most frequently used type for compression rings. Today, it is chiefly used as the first compression ring in all passenger car petrol engines and sometimes in utility vehicle diesel engines. Inside bevels and inside steps cause ring twisting in installed (tensioned) state. The position of the chamfer or the inside step on the top edge causes "positive ring twisting". A detailed description of how the twisting works can be found in chapter 1.6.9 Ring twisting.

TAPER FACED RINGS – COMPRESSION RINGS WITH AN OIL SCRAPING FUNCTION

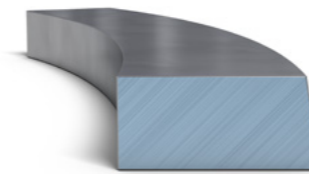

Taper faced ring

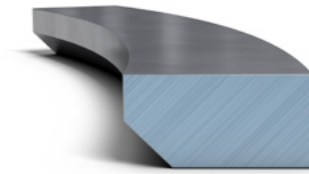

Taper faced ring with inside bevel at bottom

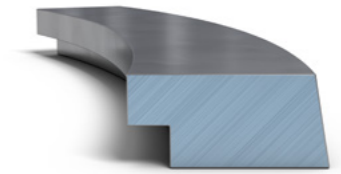

Taper faced ring with inside step at bottom

NOTE

Taper faced rings are used in all types of engine (passenger car, utility vehicle, petrol and diesel), primarily in the second ring groove.

These rings have a dual function. They support the compression ring with gas sealing and the oil control ring with regulating the oil film.

Taper faced rings (Fig. 2) have a conical mould on the sliding surface. The angle deviation from the rectangular ring is approx. 45 to 60 angular minutes depending on the version. Due to the mould, the ring only touches on the bottom edge in new state and therefore only lies in the cylinder bore at specific points. This causes a high mechanical surface pressure in this area and results in a desired material removal. This desired running in wear results in a perfect round shape after just a short operating time and achieves a good sealing effect. After a service life of several 100,000 km, the wear results in an abrasion of the conical sliding surface so that the taper faced ring carries out the function of a rectangular ring. The ring previously produced as a taper faced ring still provides a good sealing effect as a rectangular ring. Because the gas pressure also acts on the ring from the front (the gas pressure can penetrate into the sealing gap between the cylinder and piston ring sliding surface), the gas pressure increase is reduced slightly. During the running-in time of the ring, the contact pressure is slightly reduced and the running-in is more gentle with less wear.

In addition to the function as a compression ring, taper faced rings also have good oil scraping characteristics. This is achieved by the reset top ring edge. During the upwards movement from the lower to the upper top dead centre, the ring slides over the oil film. Due to the hydrodynamic forces (wedge of lubricant formation), the ring is lifted slightly off the cylinder surface. During the movement in opposite direction, the edge moves deeper into the oil film and scrapes off the oil predominantly towards the crankcase. On petrol engines, taper faced rings are also inserted in the first ring groove. The position of the chamfer or the inside step on the bottom edge has a negative ring twist here (see chapter 1.6.9 Ring twisting).

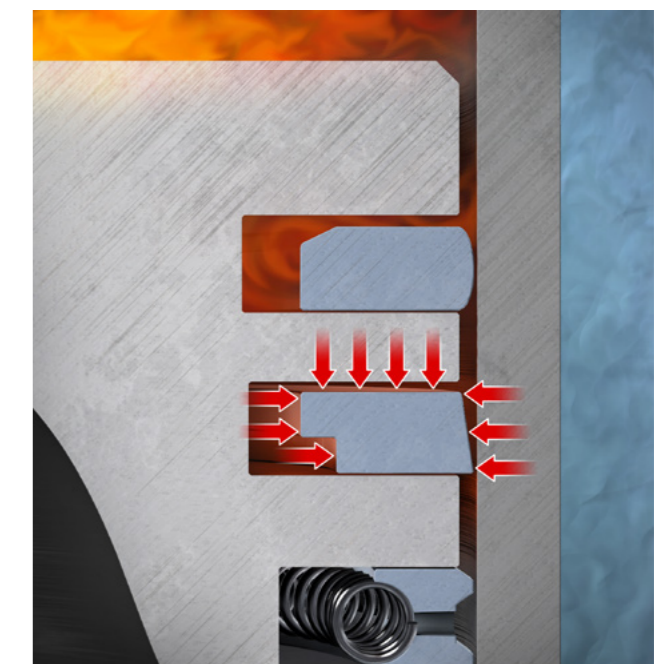

Gas pressure on the taper faced ring

NAPIER RINGS

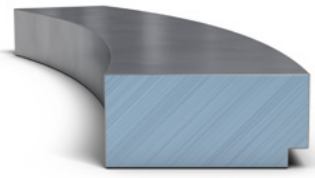

Napier ring

With the napier ring, the bottom edge of the piston ring sliding surface has a rectangular or undercut recess, which also has an oil scraping effect in addition to the gas sealing. The recess creates a certain volume, in which the scraped off oil can collect before running back into the oil pan.

In the past, the napier ring was used as a second compression ring in many engine variants. These days, taper faced napier rings are mainly used instead. Napier rings are also used with compressor pistons for pneumatic brake systems – in this case, mainly as the first compression ring.

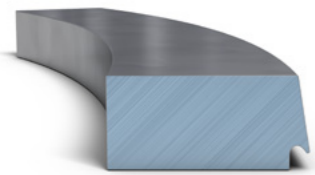

Taper faced napier ring

The taper faced napier ring is the further development of the napier ring. The oil scraping effect is increased by the conical sliding surface. With piston compressors, the taper faced napier ring is not only inserted in the second, but also in the first ring groove.

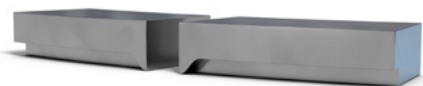

Taper faced napier ring with closed joint

With some taper faced napier rings, the undercut recess does not run to the joint end in order to improve the gas sealing function. This means that, compared with the normal taper faced napier ring, the blow-by gas emission is reduced (see also chapter 1.6.5 Joint clearance).

KEYSTONE RINGS

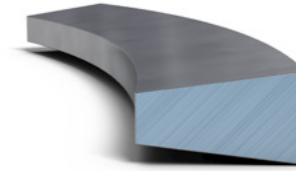

Double-sided keystone ring

With double-sided keystone rings, the two ring sides are not parallel, but are positioned trapezoidally to each other. The angle is usually 6° , 15° or 20° .

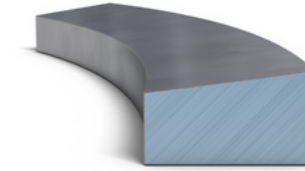

One-sided keystone ring

With one-sided keystone rings, the bottom ring side has no angle and is at a right-angle to the piston ring sliding surface.

Keystone rings or one-sided keystone rings are used to combat carbon deposits in the ring grooves, causing the rings to jam in the ring grooves. Particularly when extremely high temperatures occur within the ring groove, there is a risk that engine oil in the ring groove may become carbonised due to the temperature impact. With diesel engines, soot formation occurs in addition to potential oil coking. This also promotes deposits in the ring groove. If the piston rings were to get stuck in the groove due to deposits, the hot combustion gases would be able to pass between the piston and cylinder wall unhindered and the piston would overheat. Removal of material by melting from piston head and severe piston damage would be the result.

The keystone ring is preferably inserted in the top ring groove on diesel engine due to the higher temperatures and soot formation, and is sometimes also inserted in the second ring groove.

⚠ ATTENTION

Keystone rings (one-sided and double) may not be inserted in normal rectangular grooves. When using keystone rings, the ring grooves to be equipped on the piston must always have the corresponding shape.

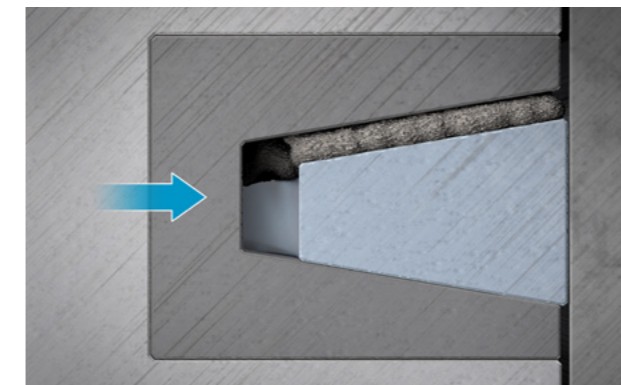

Cleaning function: Due to the shape of the keystone rings and the movement in the ring groove through the piston rocking (see chapter 1.6.11 Piston ring movements), carbon deposits are mechanically rubbed off.

1.3.2 OIL CONTROL RINGS

FUNCTION

Oil control rings are designed to distribute oil on the cylinder wall and to scrape the surplus oil off the cylinder wall. Oil control rings usually have two scraping lands to improve the sealing and scraping function. Each of these lands scrapes surplus oil off the cylinder wall. A certain amount of oil volume therefore occurs both on the bottom edge of the oil control ring and between the lands, which must be drained out of the ring area. From the point of view of the piston rocking movement within the cylinder bore, the sealing function is better the closer the two ring lands are to each other.

In particular the oil volume that is scraped off the top scraping land and which occurs between the lands must be drained off from this area, as it may otherwise get past the oil control ring and will then have to be scraped off by the second compression ring. To this end, one-part and two-part oil control rings have either longitudinal slats or bores between the ring lands. The oil scraped off the top land is guided through these openings in the ring body to the rear side of the ring.

From there, the further drainage of the scraped off oil can take place in different ways. One method is to guide oil into the oil scraping groove on the inner side of the piston through bores so that it can drip back into the oil pan from there. With so-called cover slots (Fig. 1), the scraped off oil is fed back via the recess around the pin boss on the outer side of the piston. But a combination of both versions is also used.

Both versions have proven themselves suitable for draining off the scraped off oil. Depending on the piston shape, combustion process or use, one or the other version may be used. Any general statement in favour of one or the other version would be unsatisfactory. The decision regarding which method is best suited for the relevant piston is therefore determined in various practical test runs.



Oil control ring

NOTE

For two-stroke engines, the lubrication of the piston takes place via a mixture lubrication. Due to the design, this means that there is no need to use an oil control ring.

ONE-PART OIL CONTROL RINGS

One-part oil control rings are no longer used in modern engine manufacture. They get their tension exclusively from the piston ring cross section. These rings are therefore relatively rigid and have a poorer fluidity and less effective sealing properties than multi-part oil control rings. Single-part slotted oil control rings are made from grey cast iron.



Oil control ring

MODELS

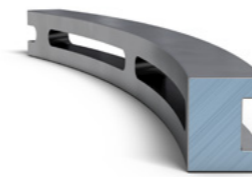

Slotted oil control ring

Simplest design with rectangular scraping lands and oil slits for oil drainage.

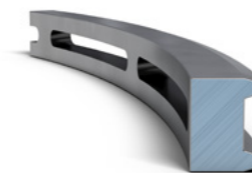

Double-bevelled oil control ring

Compared with the slotted oil control ring, the edges of the sliding lands are chamfered to achieve better surface pressure.

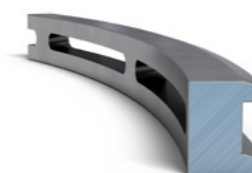

Top-bevelled oil control ring

With this ring, the sliding lands are only chamfered towards the combustion chamber side. This results in a stronger oil scraping effect during the downstroke of the piston.

TWO-PART OIL CONTROL RINGS (SPIRAL EXPANDER DESIGNS)

Two-part oil control rings consist of a ring body and a spiral spring behind it. The ring body has a significantly smaller cross section compared with the single-part oil control ring. This means that the ring body is relatively flexible and has an extremely good fluidity. The spring bed of the spiral expander on the inside of the ring body is either semicircular or v-shaped.

The actual tension comes from a coiled compression spring made from heat-resistant spring steel. This is located behind the ring and presses it against the cylinder wall. During operation, the springs lie securely on the rear side of the ring body and form a unit together. Although the spring does not twist against the ring, the entire ring unit turns – like other rings – freely in the piston ring groove. The radial pressure distribution is always symmetrical on two-part oil control rings, because the contact pressure is even over the entire circumference of the spiral spring (see also chapter 1.6.2 Radial pressure distribution).

To increase the durability, the outer diameters of the springs are ground, wound tighter on the ring joint or coated with a teflon sheath. With these measures, the friction wear is minimized between the ring body and spiral spring. The ring bodies of the two-part rings are made of either grey cast iron or steel.

NOTE

The free gap – the distance of the joint ends of the ring body in dismantled state without the expander spring behind it – is irrelevant for multi-part oil control rings. The free gap can be almost zero with steel rings in particular. This is not a defect or a reason for complaint.

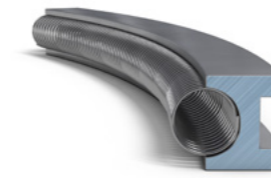

Slotted oil control ring with spiral expander

Simplest model with better sealing effect than with the single-part slotted oil control ring.

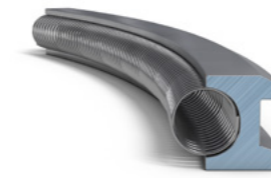

Spiral expander top-bevelled oil control ring

Same sliding surface shape as with the top-bevelled oil control ring, but with better sealing effect.

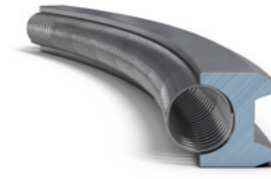

Double-bevelled spiral expander ring

Same sliding surface shape as with the double-bevelled oil control ring, but with better sealing effect. This is the most widely used oil control ring. It can be used in any engine version.

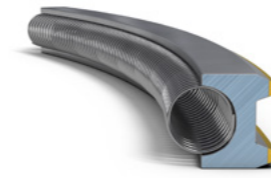

Double-bevelled spiral expander ring with chrome-plated sliding lands

Same characteristics as with the double-bevelled spiral expander ring, but with increased wear resistance, resulting in higher durability. This makes it particularly well suited for diesel engines.

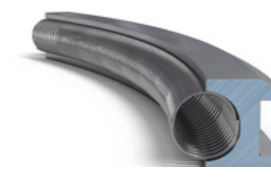

Double-bevelled spiral expander ring made from nitrided steel

This ring is wound from a profile steel strip and has an antiwear protective coat on all sides. It is extremely flexible and less prone to breakage than the cast iron rings mentioned above. The oil drainage between the rails is achieved via punched round openings. This type of oil control ring is used mainly on diesel engines.

THREE-PART OIL CONTROL RINGS

Three-part oil control rings consist of two thin steel rails, which are pressed against the cylinder wall by a spacer expander spring. Steel rail oil control rings are available with either chrome-plated sliding surfaces or nitrided on all sides. The latter offers better wearing properties on the sliding surface and between the expander spring and the lamella (secondary wear). Three-part oil control rings have an extremely good fluidity and are used mainly on petrol engines in passenger cars.

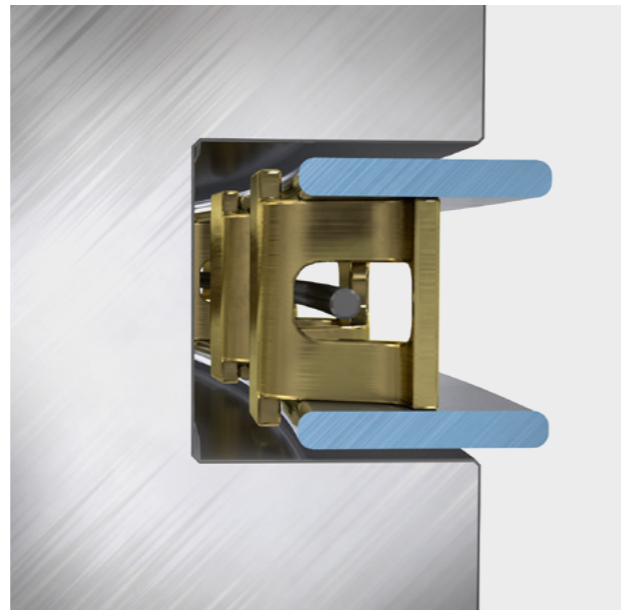

Three-part oil control ring

1.3.3 TYPICAL PISTON RING FITTING

The complex requirements placed on the piston rings can not be met by just one piston ring. This can only be achieved with a combination of different piston ring types. In modern vehicle engine manufacture, a combination of a compression ring, a combined compression and scraper ring and a pure oil control ring has therefore become an established solution. Pistons with more than three rings are relatively rare today.

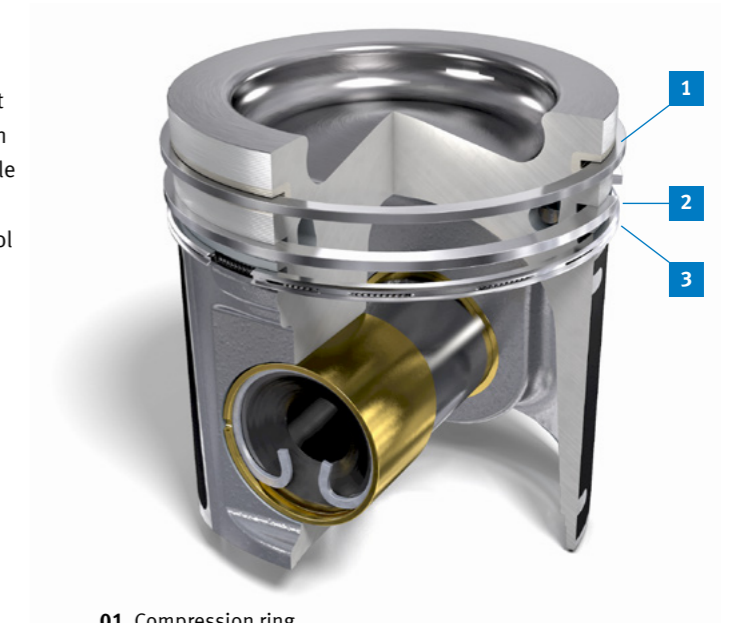

- 01 Compression ring
- 02 Compression and scraper ring
- 03 Oil control ring

1.3.4 THE MOST COMMON PISTON RING

There is no such thing as the best piston ring, nor the best piston ring fitting. Each piston ring is a 'specialist' in its field. Each ring version and ring composition is ultimately a compromise of completely different and, in some cases, contradictory requirements. Changing just one piston ring can create imbalance in the entire ring set combination.

The final piston ring combination for a newly designed engine is defined based on extensive test runs on the test rig – as well as under normal operating conditions.

The table below is not guaranteed to be complete, but shows how different ring characteristics impact on the different ring functions.

- favourable – positive
- medium – neutral
- unfavourable – negative

| Requirement | Friction | Running-in | Durability |
|-------------------------|----------|------------|------------|
| High ring tension | ● | ● | ● |
| Low ring tension | ● | ● | ● |
| Wear resistant material | - | ● | ● |
| Softer material | - | ● | ● |
| Low ring height | ● | ● | ● |
| High ring height | ● | ● | ● |

1.4 PISTON RING DESIGNATIONS

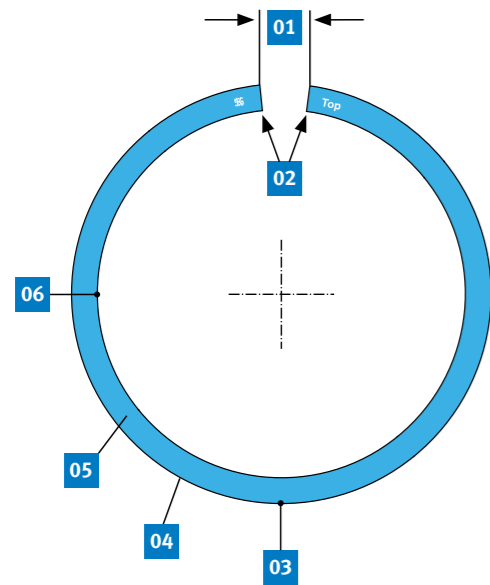

- 01 Free gap
- 02 Joint ends
- 03 Back of the ring (opposite joint ends)
- 04 Piston ring sliding surface
- 05 Ring flank surface
- 06 Piston ring internal surface

- 07 Joint clearance (cold clearance)
- 08 Cylinder diameter

- 09 Radial wall thickness
- 10 Axial play
- 11 Piston ring height
- 12 Cylinder diameter
- 13 Groove base diameter
- 14 Groove height
- 15 Radial play

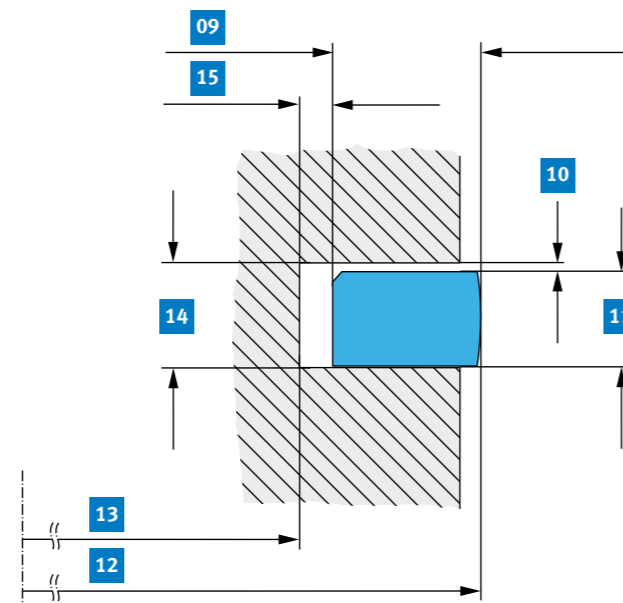
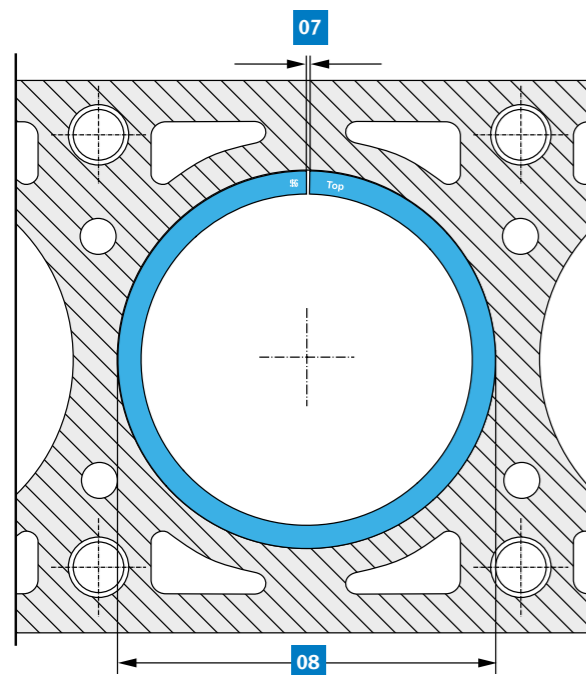

1.5 STRUCTURE AND SHAPE OF PISTON RINGS

1.5.1 PISTON RING MATERIALS

Piston ring materials are selected based on runnability and the conditions that the piston rings have to work under. Good elasticity and corrosion resistance are just as important as a high resistance to damage under extreme operating conditions. Grey cast iron is still the main material used to manufacture piston rings today. From a tribological perspective, grey cast iron and the graphite deposits in the joint offer extremely good emergency running properties (dry lubrication via graphite).

These are particularly important if the lubrication via engine oil is no longer guaranteed or the lubricating film is already destroyed. Graphite veins within the ring structure also act as an oil reservoir and, here to, serve to combat the destruction of the lubricating film under adverse operating conditions.

The following materials are used as grey cast iron materials

- Cast iron with lamellar graphite structure (lamellar graphite cast iron), annealed and non-annealed
- Cast iron with nodular graphite structure (nodular cast iron), annealed and non-annealed

Chrome steel with martensitic microstructure and spring steel are used as steel. To increase the wear resistance, the surfaces are hardened. This usually takes place via nitriding*.

* In specialist language, nitriding refers to the supply of nitrogen and is a process for hardening steel. Nitriding is usually carried out at temperatures between 500 and 520 °C with treatment times of 1 to 100 hours. Nitrogen is diffused onto the workpiece surface to form an extremely hard, superficial compound layer of iron nitride. Depending on the treatment time, this can have a thickness between 10–30 µm. Common methods include salt bath nitriding (e.g. crankshafts), gas nitriding (with piston rings) and plasma nitriding.



Piston ring casting process

1.5.2 COATING MATERIALS OF SLIDING SURFACES

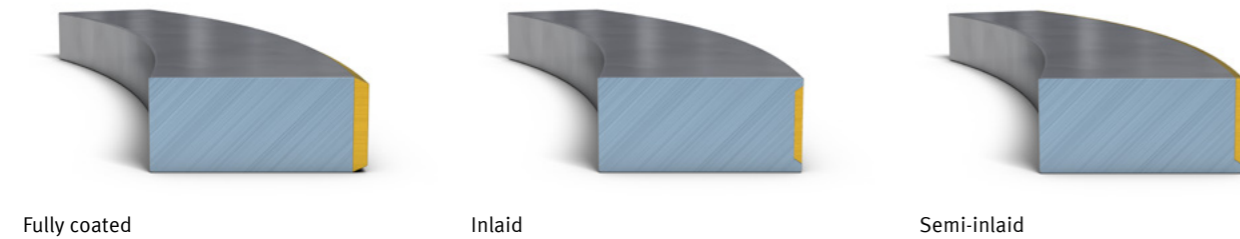

The sliding lands or sliding surfaces of piston rings can be coated to improve the tribological* characteristics. The focus here is on increasing the wear resistance and ensuring the lubrication and sealing under extreme conditions. The coating material must work harmoniously with the materials of the piston ring and the cylinder wall, as well as with the lubricant. The use of surface coatings is therefore widely spread on piston rings. The rings of series engines are often coated with chrome, molybdenum and ferrous oxide.

* Tribology (Greek) covers the research field and technology of interactive surfaces in relative movement. It deals with the scientific description of friction, wear and lubrication.

MOLYBDENUM COATINGS

To protect the rings against burn marks, the sliding surface of compression rings (not oil control rings) can be filled or coated on one surface with molybdenum. Flame spraying or plasma spraying procedures can be used for this. With its high melting point (2620 °C), molybdenum guarantees an extremely high temperature resistance. The coating procedure also creates a porous material structure. Engine oil can collect in the resulting micro-cavities on the sliding surface of the rings (Fig. 2). This ensures that engine oil is still present for lubricating the piston ring sliding surface even under extreme operating states.

Characteristics

- High temperature resistance
- Good emergency running properties
- Softer than chrome
- Less wear resistant than chrome rings (more susceptible to dirt)
- More sensitive to ring flutter (with potential molybdenum outbreaks in cases of extreme strain, e.g. with knocking combustion and other combustion defaults)

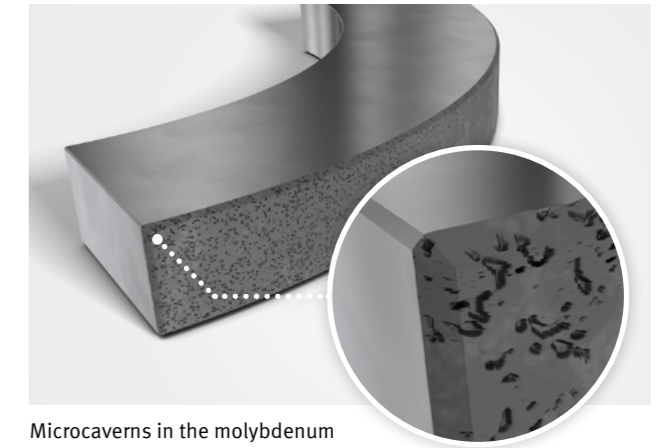

Microcavens in the molybdenum coating

GALVANIC COATINGS

CHROMIUM PLATINGS

Most chromium platings are achieved with galvanic processes.

Characteristics

- High durability (wear resistant)
- Hard, non-sensitive surface
- Reduced cylinder wear (approx. 50% compared with uncoated piston rings)
- Good resistance against burn marks
- Lower emergency running properties than with molybdenum coatings
- Good wear resistance provides: a longer running-in time than with unreinforced piston rings, steel rail oil control rings or U-flex oil control rings

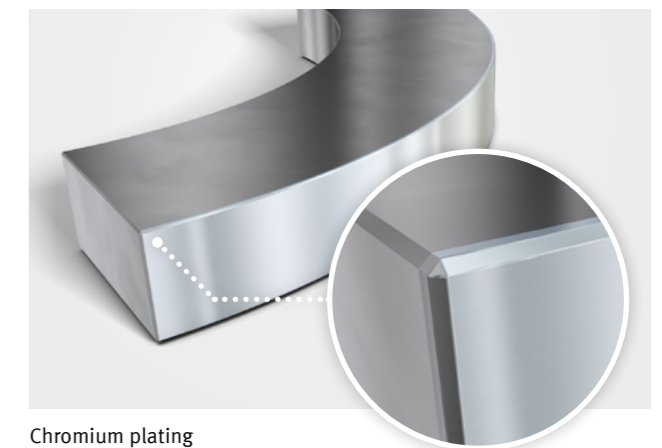

Chromium plating

CC COATINGS (CHROME-CERAMICS) AND DC COATINGS (DIAMOND COATED)

These coatings consist of a galvanised chromium layer with a network of cracks, into which firmly anchored hard materials are embedded. Ceramic (CC) or microdiamonds (DC) are used as the integrated material.

Characteristics

- Minimal frictional loss due to extremely smooth surface
- Maximum wear resistance and high durability due to embedded hard materials
- Good burn mark resistance
- Low wear on the layer of the piston ring, with consistently low cylinder wear

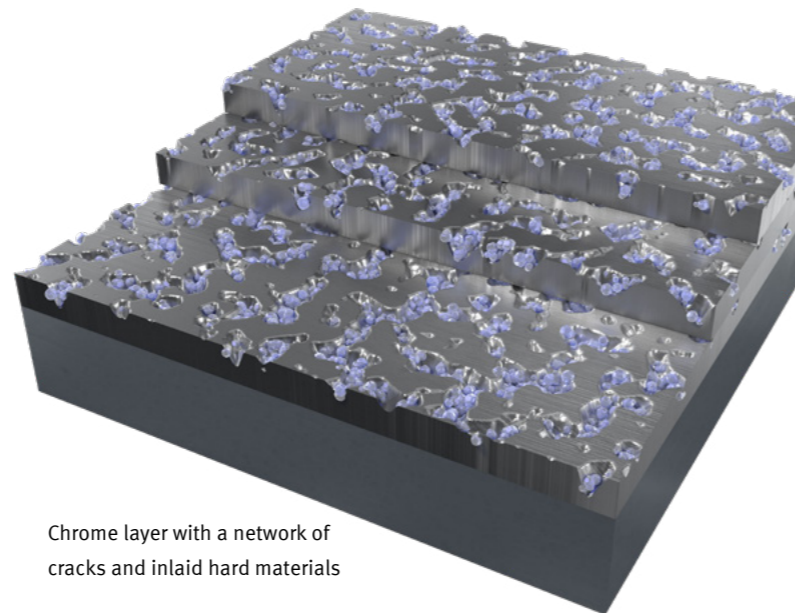

Chrome layer with a network of cracks and inlaid hard materials

PVD COATINGS

PVD stands for “Physical Vapour Deposition”, a vacuum-based coating procedure, where hard material layers (CrN – chrome(III)-nitride) are applied directly on the piston ring surface via vapour deposition.

Characteristics

- Frictional losses are minimized due to an extremely smooth surface.
- Extremely high wear resistance is achieved with an ultra-thin and dense layer structure with a high hardness level.
- Due to the high wear resistance, the ring contour is retained over a longer service life. With a PVD-coated oil control ring, for example, the ring tension can be reduced further, resulting in significant friction advantages.

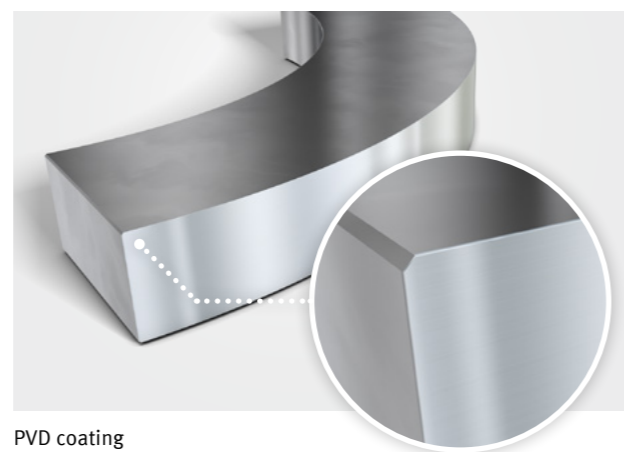

PVD coating

1.5.3 DETACHMENT OF COATING

Detachment of surface coatings occurs occasionally with sprayed-on molybdenum and ferrous oxide layers. The main reason for this is faults with mounting the piston rings (excessive spreading when pulling on to the piston and pulling on the rings, as shown in Fig. 1). If the rings are pulled incorrectly on to the piston, the coating only breaks on the back of the ring (Fig. 2). If the coating is flaking off on the joint ends, this is an indication of ring flutter due to combustion faults (e.g. knocking combustion).



Fig. 1: Twisting and spreading of the piston rings when pulling onto the piston



Fig. 2: Coating breaks out on the back of the ring.

1.5.4 SLIDING SURFACE MACHINING (TURNED, LAPPED, GROUND)

Unreinforced piston rings made from cast iron are usually only precision-turned on the sliding surface. Due to the quick running-in time of unreinforced rings, no grinding or lapping takes place on the sliding surface. With coated or hardened surfaces, the sliding surfaces are either ground or lapped. The reason for this is that, due to the high wear resistance, it would take an extremely long time for the rings to take on a round shape and seal correctly. This may result in loss of power and high oil consumption.

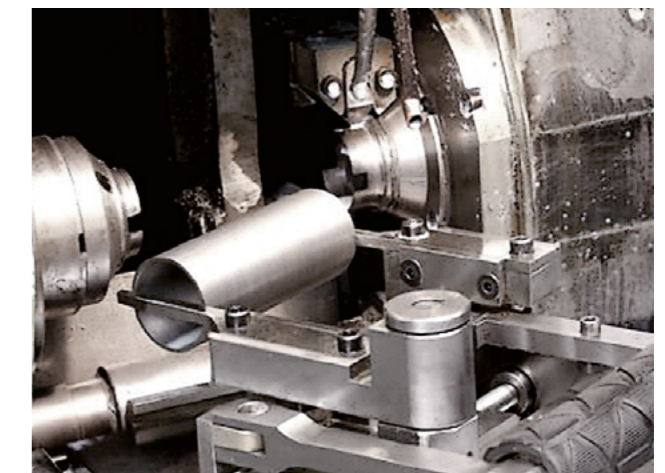

Lathe for sliding surface machining

1.5.5 CROWNED SLIDING SURFACE SHAPES

Another reason for the use of grinding and lapping processes in the shape of the sliding surface. Rectangular piston rings (unreinforced) take on a crowned shape on the sliding surface after a period of time (Fig. 1) – the reason for this is the upwards and downwards movement and the movement of the ring in the groove (ring twist). This has a positive impact on the lubricating film build-up and durability of the rings.

During the production of coated piston rings, the rings are already given a slight crowned shape. This means that they do not have to run in to the desired shape first, but already have a pre-run in sliding surface. This eliminates the high run-in wear and associated oil consumption. Due to the point-based contact with the piston ring sliding surface, a higher specific contact pressure occurs on the cylinder wall, resulting in an improved gas and oil sealing effect. The risk of edge riding is also reduced through even sharper ring edges. Chrome rings always have a bevelled edge to prevent the oil film from being pushed through during running-in. The extremely hard chrome layer could lead to significant wear in case of sub-optimal design and cause damage on the much softer cylinder wall.

Symmetrical, crowned piston ring sliding surfaces (Fig. 2), created either through running-in or during ring production, have extremely good sliding properties and create a defined lubrication film thickness. With symmetrical crowning, the lubricating film thickness is equal during the upstroke and downstroke of the piston. The forces on the ring, which cause the ring to float on the oil film, are the same in both directions.

If the crowning is created during the ring production, there is the option of creating an asymmetrical crowning for better oil consumption control. The peak of the crowning is then not in the centre of the sliding surface, but slightly below it (Fig. 3).

This asymmetrical pitch of the sliding surface creates a different sliding surface during the upwards and downwards movement of the ring. During the upwards movement, the ring is pressed away from the oil more due to the larger surface area and less oil is scraped off. During the downwards movement, the smaller surface area means that the piston ring floats less and scrapes off more oil (Fig. 4 and 5).

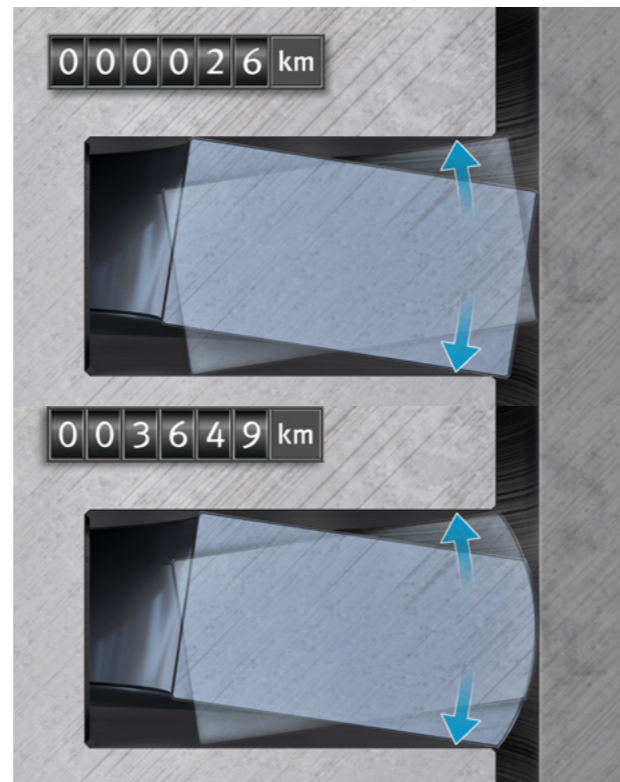

Fig. 1: Crowning due to running-in wear

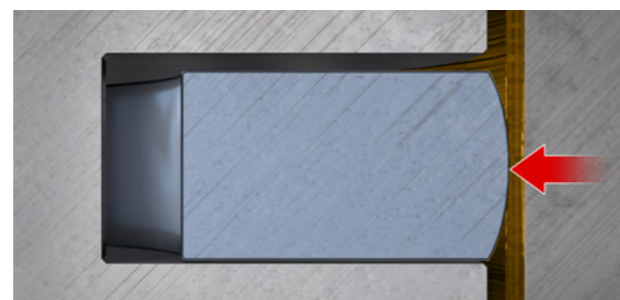

Fig. 2: Symmetrically crowned piston ring sliding surface



Fig. 3: Asymmetrically crowned piston ring sliding surface

Asymmetrically crowned rings are thus also used for the oil consumption control, particularly in adverse operating conditions in diesel engines. This occurs, for example, after longer idling periods, where oil is often released in the exhaust tract and blue smoke is often generated when the accelerator is pressed again.



Fig. 4: High floating during the upwards movement

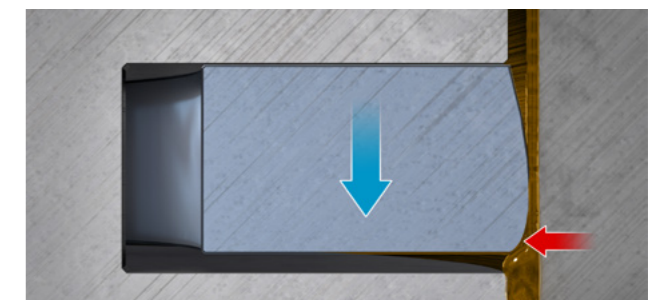

Fig. 5: Low floating in the downwards movement

1.5.6 SURFACE TREATMENTS

Depending on the version, the surfaces of piston rings can either be bare, phosphated or copper-plated. This only has an impact on the corrosion behaviour of the rings. Though bare rings may shine beautifully in new condition, they are completely unprotected against rust formation. Phosphated rings have a black matt surface and are protected from rust formation by the phosphate coat.

Copper-plated rings are also protected effectively from rust and have slight protection from formation of burn marks during running-in. The copper has a certain dry lubricating effect, resulting in minimal emergency running properties during running-in.

The surface treatments have no impact on the function of the rings, however. So the colour of the piston ring also gives no indication of the quality.



1.6 FUNCTION AND PROPERTIES

1.6.1 TANGENTIAL TENSION

Piston rings have a larger diameter in relaxed state than in installed state. This is necessary to create the required contact pressure on all sides in the cylinder.

In practice, measuring the contact pressure in the cylinder is difficult. The diametral load that presses the ring on to the cylinder wall is therefore determined from the tangential force based on a formula. The tangential force is the force required to pull the joint ends together on the joint clearance (Fig. 1). The tangential force is measured with a flexible steel strip placed around the ring. The strip is pulled together until the specified joint clearance of the piston ring is achieved. The tangential force can then be read off on the dynamometer. The measurement of oil control rings always takes place with the expander spring inserted.

To guarantee exact measurements, the measurement set-up is placed under vibration so that the expander spring can take on its natural shape behind the ring body. With three-part steel rail spring washers, axial fixing of the ring package is also necessary due to the design, as the steel rails would otherwise be deflected at the side and the measurement would not be possible. Fig. 1 shows the schematic diagram of the tangential force measurement.

NOTE

With piston rings, radial wear caused by mixed friction or long service life, results in a loss of tangential tension. It is only useful to measure the tension with new rings with a cross section that is still full.

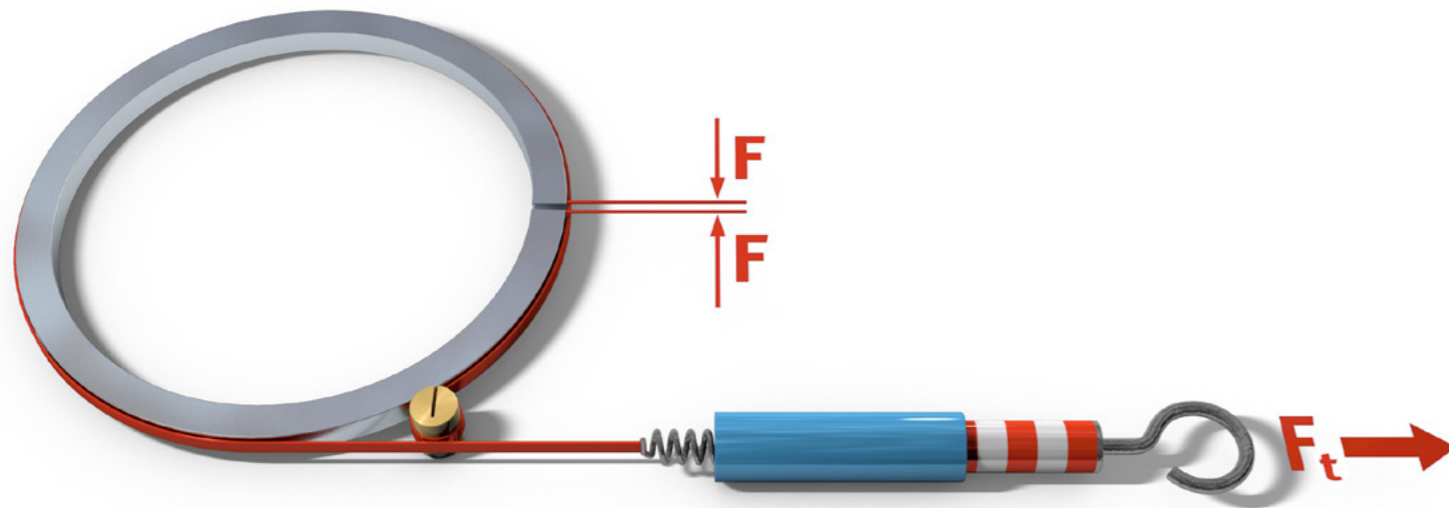

Fig. 1: Tangential force measurement

1.6.2 RADIAL PRESSURE DISTRIBUTION

The radial pressure depends on the modulus of elasticity of the material, the free gap in untensioned state and, last but not least, the cross section of the ring. There are two main methods of differentiation with radial pressure distribution. The easiest method is the symmetrical radial pressure distribution (Fig. 2). This is the case with multi-part oil control rings in particular, which consist of a flexible ring carrier or steel rails with a relatively low internal stress. The expander spring behind presses the ring carrier or the steel rails against the cylinder wall. The expander spring, which is supported against the rear side of the ring carrier or steel rail in compressed state (installed situation), causes the radial pressure to act symmetrically.

Four-stroke engines deviate from the symmetrical radial pressure distribution with compression rings. A pear-shaped distribution (positive-oval) is used instead to combat a tendency to flutter on the ring joint ends at higher speeds (Fig. 3). Ring flutter always starts at the joint ends and is transferred from there over the entire ring circumference. The increase in the pressure force on the joint ends combats this, as the piston rings in this area are pressed more forcefully onto the cylinder wall, effectively reducing or preventing ring flutter.

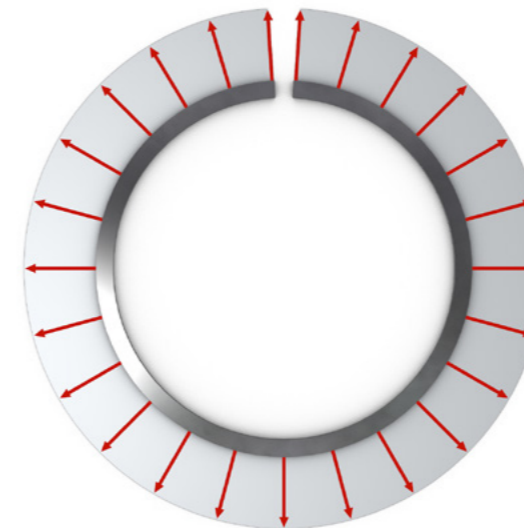

Fig. 2:
Symmetrical radial
pressure distribution

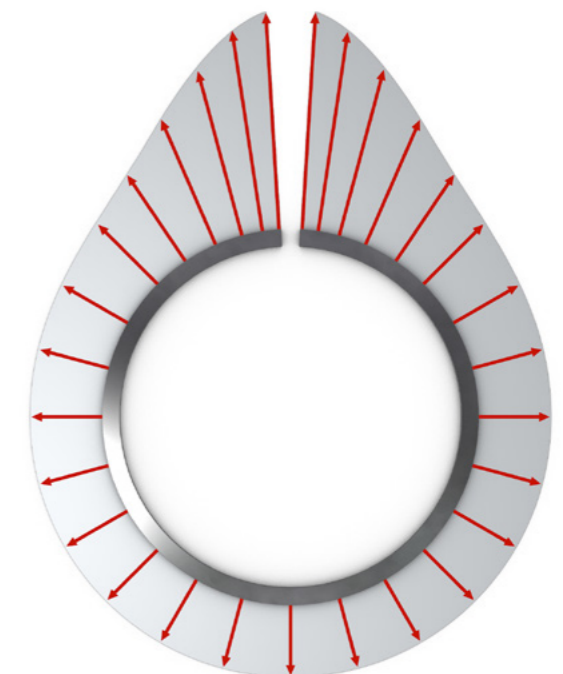

Fig. 3:
Positive-oval radial pressure
distribution

1.6.3 INCREASE IN CONTACT PRESSURE DUE TO COMBUSTION PRESSURE

Much more important than the internal stress of the piston rings is the increase in contact pressure due to the combustion pressure acting on the compression rings during engine operation.

Up to 90% of the total pressure force of the compression ring is generated by combustion pressure during the combustion cycle. As shown in Fig. 1, the pressure is applied behind the compression rings and presses them even more firmly against the cylinder wall. This increase in contact pressure acts mainly on the first compression ring and to a lesser degree on the second compression ring.

The gas pressure for the second piston ring can be controlled by varying the joint clearance of the first compression ring. With a slightly larger joint gap, more combustion pressure is applied on the rear side of the compression ring, for example, which causes an increase in the contact pressure here too.

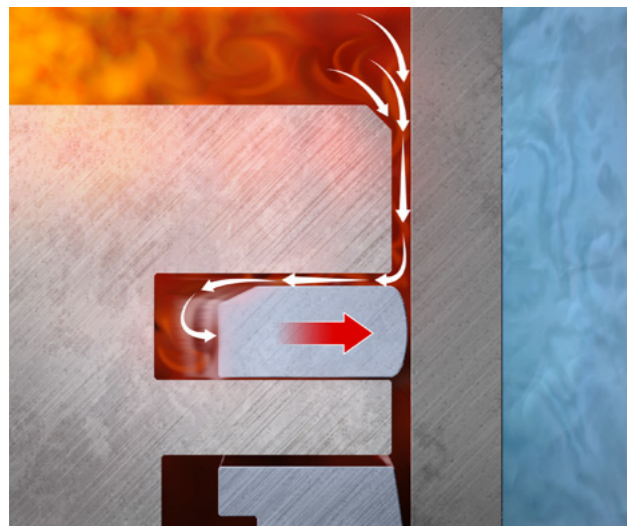

Fig. 1: Increase in contact pressure

With a higher number of compression rings, no further increase in contact pressure occurs from the second compression ring onwards as a result of the increase in contact pressure.

Pure oil control rings only work based on their internal stress. The gas pressure can not act as a contact pressure amplifier here due to the special shape. The distribution of forces on the piston ring is also dependent on the shape of the piston ring sliding surface. With taper faced rings and crowned ground compression rings, gas pressure also enters the sealing gap between the piston ring sliding surface and cylinder wall and acts against the gas pressure applied behind the piston ring (see chapter 1.3.1 Compression rings).

The axial pressure force acting on a compression ring on the bottom groove side is only generated by the gas pressure. The internal stress of the rings does not act in axial direction.

NOTE

During idling, the poorer filling of the cylinders results in a lower contact pressure increase on the rings. This is particularly notable on diesel engines. Engines left idling for a long time have increased oil consumption, as the scraping action suffers from a lack of gas pressure support. Often, the engines emit blue oil clouds from the exhaust after a longer idling period, because oil was able to collect in the cylinder and exhaust tract and is only burnt when the accelerator is pressed.

1.6.4 SPECIFIC CONTACT PRESSURE



Fig. 2 and Fig. 3: Ring tension and specific pressure force

The specific contact pressure depends on the ring tension and the contact surface of the ring on the cylinder wall. There are two options for doubling the specific pressure force: Either the ring tension is doubled or the contact surface of the ring is halved in the cylinder. In Fig. 2 and Fig. 3, it is apparent that the resulting force (specific pressure force = force \times surface) acting on the cylinder wall is always equal, even though the ring tension has been doubled or halved.

On newer engines, the trend is leaning towards flatter ring heights, as the goal is to reduce the internal friction in the engine. This can only be achieved, however, if the active contact area of the ring with the cylinder wall is reduced. With half the ring height, the piston ring tension is also halved, and thus also the friction.

Because the remaining force acts on a smaller area, the specific contact pressure on the cylinder wall (force \times area) with half the surface and half the tension is as large as with double the area and double the tension.

ATTENTION

The ring tension can not be used on its own to assess the contact pressure of the sealing behaviour. When comparing piston rings, the size of the sliding surface must always be taken into account.

1.6 FUNCTION AND PROPERTIES

1.6.5 JOINT CLEARANCE

The joint clearance (Fig.1) is an important constructional feature to guarantee the function of the piston rings. It is therefore comparable with the valve clearance of the intake and exhaust valves. When the components are warmed up, the natural thermal expansion results in an extension or diameter expansion. Depending on the difference between the ambient and operating temperature, more or less cold clearance is required to guarantee the function when running at operating temperature.

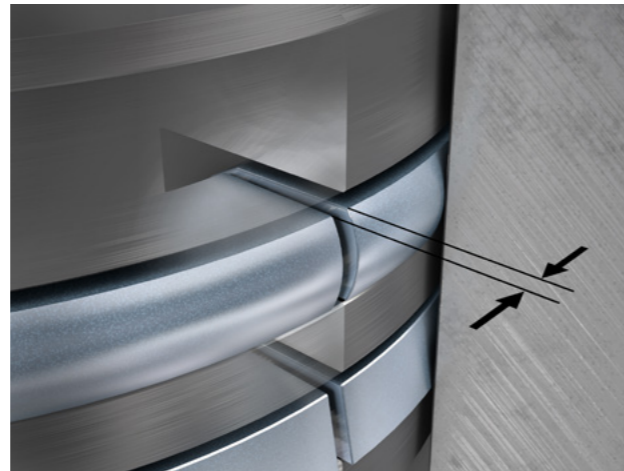

Fig. 1: Joint clearance in installed state

One basic requirement for the correct function of the piston rings is that they must be able to turn freely in the grooves. If piston rings were to become jammed in the grooves, they would neither seal nor dissipate the heat. The joint clearance that must also be present at operating temperature, guarantees that the circumference of the piston ring always remains smaller than the cylinder circumference due to its thermal expansion. If the joint clearance were to be removed completely due to the thermal expansion, the joint ends of the piston rings would be pressed against each other. If further pressure were to be applied, the piston ring would even have to bend to compensate for the change in length due to the heat. Because that piston ring would be unable to expand in radial direction due to thermal expansion, the change in length could only be compensated for in axial direction. Fig. 2 shows how the ring is deformed if space becomes too tight in the cylinder.

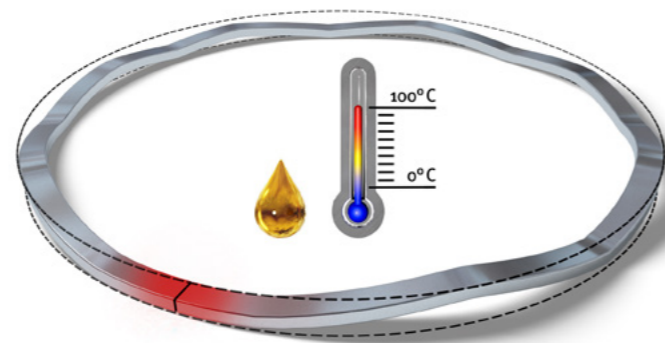

Fig. 2: Deformation of the piston ring at operating temperature

The following calculation shows, based on the example of a piston ring with 100 mm diameter, how the length of the circumference changes on the piston ring in operating temperature.

Example calculation

| | | |
|--|----------------|----------------------------|
| Cylinder diameter | d | = 100 mm |
| Ambient temperature | t ₁ | = 20 °C = 293 K |
| Operating temperature | t ₂ | = 200 °C = 473 K |
| Coefficient of linear expansion of cast iron | α | = 0.000010 K ⁻¹ |

Circumference of the piston ring

$$U = d \times \pi$$

$$U = 100 \times 3.14 = 314 \text{ mm}$$

$$U = l_1$$

Change in length of the piston ring under operating temperature

$$\Delta l = l_1 \times \alpha \times \Delta t$$

$$\Delta l = l_1 \times \alpha \times (t_2 - t_1)$$

$$\Delta l = 314 \times 0.000010 \times 180 = 0.57 \text{ mm}$$

In this example, a joint clearance of at least 0.6 mm is therefore required to ensure the correct function. So it is not only the pistons and the piston rings that expand, but also the diameter of the cylinder bore, which also becomes larger when heated up at operating temperature. This means that the joint clearance may be slightly smaller again. But the cylinder bore does not expand anywhere near as much as the piston ring as a result of the thermal expansion. On the one hand, the structure of the cylinder block is more rigid than that of the piston, on the other hand, the cylinder surface is not as hot as the piston with the piston rings.

The diameter expansion of the cylinder bore as a result of the thermal expansion is not equal over the entire running surface of the cylinder liner. The cylinder will expand more in the top area due to the heat introduction from the combustion than in the bottom area. Therefore, due to the uneven thermal expansion of the cylinder, a deviation in the cylinder shape will occur, which takes on a slight funnel shape (Fig. 3).

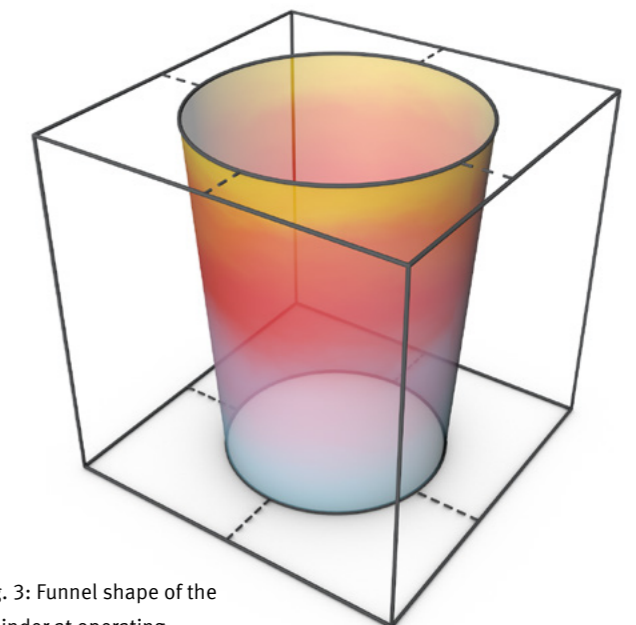

Fig. 3: Funnel shape of the cylinder at operating temperature

1.6.6 PISTON RING SEALING FACES

Piston rings not only seal on the sliding surface, but also on the lower flank. The sealing effect on the sliding surface is responsible for the ring sealing to the cylinder wall; the bottom groove side is responsible for sealing the rear side of the ring. So good contact between the ring and the cylinder wall is required, as well as good contact with the bottom groove side of the piston (Fig. 1). Without this contact, oil or combustion gases can pass by the ring via the rear side of the ring.

The figures clearly show that the wear (dirt and long service life) means that the sealing on the rear side of the ring is no longer guaranteed and that higher levels of gas and oil transfer occur through the groove. It is therefore not helpful to fit new rings in worn ring grooves. The unevennesses on the groove side do not seal against the ring and the expanded height of the groove allows the ring to move more freely. Because the ring is not guided correctly in the groove due to excessive height clearance, the ring lifts much more easily off the groove side, oil is pumped much more easily (Fig. 2 and 3) and ring flutter and loss of sealing effect occur much more readily. Excessive crowning also occurs on the sliding surface of the ring. This results in an excessively thick oil film and increased oil consumption.



Fig. 1: Sealing through the groove side



Fig. 2: Intake cycle



Fig. 3: Compression cycle

1.6.7 THROTTLE GAP AND BLOW-BY

Because, due to the design, it is not possible to achieve 100% gas sealing with the piston rings used in engine manufacture, leak gas quantities occur, which are also known as blow-by gases. Combustion gases pass into the crankcase past pistons and piston rings through even the smallest sealing gaps. The leakage gas quantity is determined by the size of the gas leakage area (x and y in Fig. 4), which can be calculated based on the joint clearance and half the piston-to-wall clearance. In contrast to the graph shown, the gas leakage area is actually extremely small. As a rule of thumb for the maximum blow-by gas emission, around 0.5% of the air intake quantity is expected. More or less blow-by gas is generated during operation depending on the piston ring position. If the joint clearances of the first and second compression ring match in the piston ring grooves, slightly more blow-by is generated. This occurs at regular intervals during operation, as the rings turn at several rotations per minute in the ring grooves. If the joint clearances are exactly opposite each other, the leakage gas has another route through the sealing labyrinth, meaning that reduced gas losses occur. Blow-by gas that enters the crankcase is fed back into the intake air system via the crankcase ventilation and supplied to the combustion. The reason for this is the health-damaging characteristics of the gases. These are rendered harmless by the repeat combustion in the engine. The ventilation of the crankcase is also required, because excess pressure in the crankcase would result in increased oil leakage on the radial oil seals of the engine.

If the blow-by gas emission increases, this either indicates significant wear on the piston rings after a long service life, or the piston crown already has cracks that allow combustion gases to enter the crankcase. But an incorrect cylinder geometry (see chapter 2.3.5 Cylinder geometry and roundness) also leads to increased blow-by gas emission.

With stationary engines or test-rig engines, the blow-by gas emission is measured and monitored constantly and used as a warning indicator for emerging engine damage. If the measured blow-by gas volume exceeds the maximum permissible value, the engine is switched off automatically. This helps to avoid severe and expensive engine damage.

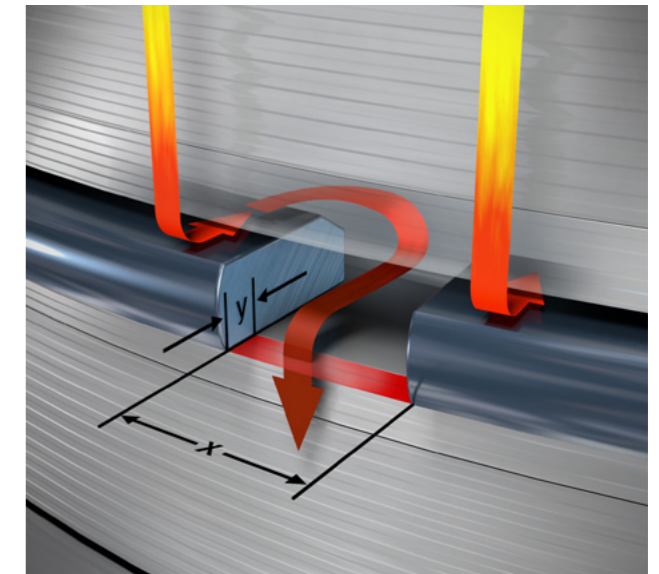

Fig. 4: Gas leakage area

1.6.8 RING HEIGHT CLEARANCE

The ring height clearance (Fig. 1) is not the result of wear in the ring groove. The height clearance is an important functional dimension to ensure the correct function of piston rings. The ring height clearance guarantees that the rings can move freely in the piston ring grooves (see also chapter 1.6.11 Piston ring movements).

It must be large enough that the ring does not become jammed under operating temperature and that sufficient combustion pressure can flow into the groove to build up behind the ring (see also chapter 1.6.3 Increase in contact pressure due to combustion pressure).

But, conversely, the ring height clearance must not be too large, as the ring would receive less axial guidance. This promotes ring flutter (chapter 2.6.7 Ring flutter) and also excessive twisting. The result is problematic wear on the piston ring (excessive crowning on the piston ring sliding surface) and increased oil consumption (chapter 1.6.6 Piston ring sealing faces).

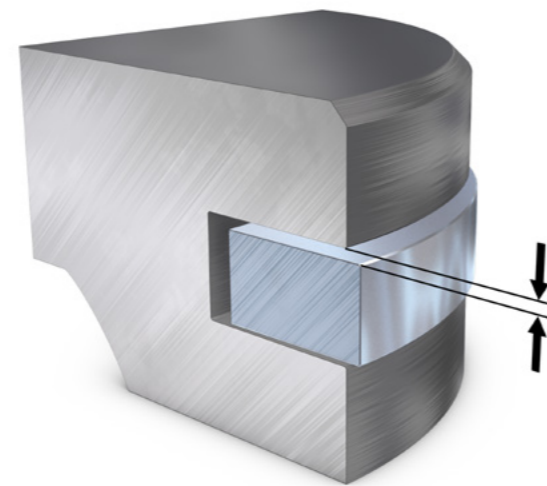

Fig. 1: Ring height clearance

1.6.9 RING TWISTING

Inside steps or inside bevels on piston rings result in twisting in tensioned, installed state. In dismantled, untensioned state, the twisting is not effective (Fig. 2) and the ring lies flat in the ring groove.

If the ring is installed – i.e. tensioned – the ring is deflected to the weaker side, where material is missing due to the inside bevel or the inside step. The ring is bent or twisted. Depending on the position of the chamfer or the angle on the bottom or top edge, we refer to a positive or negative twisting piston ring (Fig. 3 and 4).

RING TWIST UNDER OPERATING CONDITIONS

With positively and negatively twisting rings, the twisting is effective if no combustion pressure is acting on the ring (Fig. 5). As soon as the combustion pressure enters the ring groove, the piston ring is pressed flat on the bottom groove side, creating improved oil consumption control (Fig. 6).

Positive twisting rectangular and taper faced rings have a good oil scraping behaviour in principle. If friction occurs on the cylinder wall during the downstroke of the piston, the ring may lift off the bottom groove side slightly, however, so that oil still enters the sealing gap and contributes to the oil consumption.

The negatively twisting ring seals on the bottom ring side on the outside and against the ring groove on the top side on the inside. This blocks the oil from entering the groove. This means that the oil consumption can be influenced positively with negatively twisting rings, particularly in part-load operation and with vacuum in the combustion chamber (overrun condition). With negatively twisting rings, the angle on the sliding surface is 2° larger than with normal taper faced rings. This is necessary, because the negative twisting of the angle is partially removed again.



Fig. 2: Piston rings untensioned – twisting still ineffective



Fig. 3: Positive twist



Fig. 4: Negative twist



Fig. 5: Without combustion pressure



Fig. 6: With combustion pressure

1.6.10 FLUIDITY

Fluidity refers to how well the ring adapts to the shape of the cylinder wall to achieve a good sealing effect. The fluidity of a ring depends on the elasticity of the ring or ring body (two-part oil control rings) or the steel rails (multi-part oil control rings), as well as the contact pressure of the ring / ring body on the cylinder wall. The fluidity is better the more elastic the ring/ring body is and the higher the contact pressure. Large ring heights and large ring cross sections have a high rigidity and also result in higher inertial forces during operation due to the higher weight. They therefore don't fair as well in terms of fluidity as rings with low ring heights and low ring cross sections, resulting in lower inertial forces.

Multi-part oil control rings offer extremely good fluidity, as they have a highly flexible ring body or steel rails, without having to fulfil high tension requirements.

As described in this brochure, the pressure force for multi-part oil control rings comes from the corresponding expander springs. The ring body or steel rails are extremely flexible and adaptable.

Good fluidity is particularly important if cylinder irregularities and cylinder unevennesses occur due to form deviations. These are caused by distortions (thermal and mechanical), as well as by machining and fitting errors. See also chapter 2.3.5 Cylinder geometry and roundness.

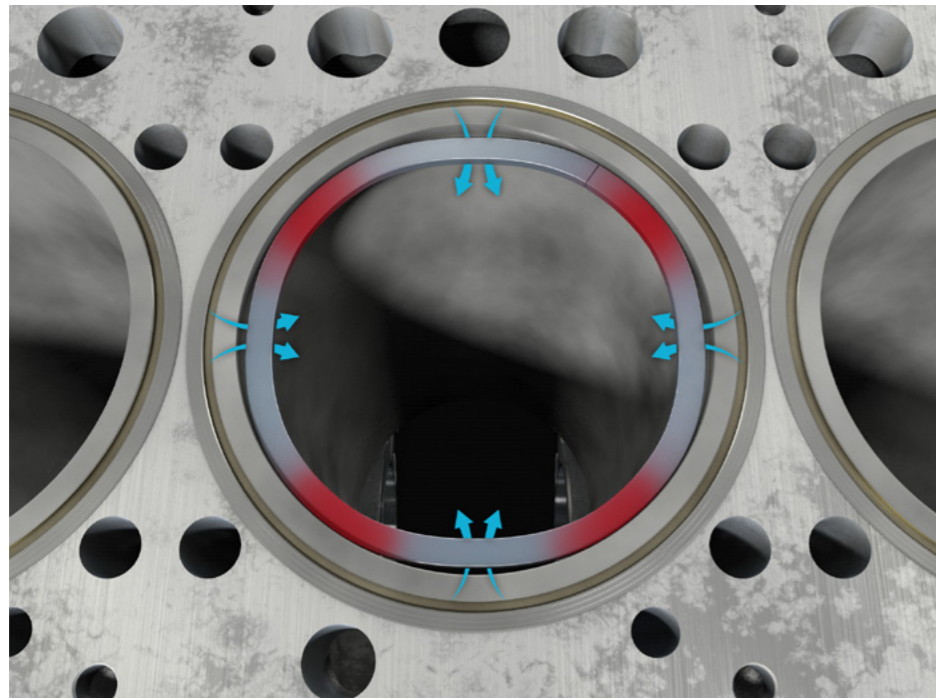

Fig. 1: Poor fluidity

1.6.11 PISTON RING MOVEMENTS

RING ROTATION

In order to run in and seal perfectly, piston rings must be able to turn in the ring grooves. The ring rotation is created on the one hand by the honing structure (cross-hatch), as well as by the piston rocking movement in the upper and lower piston dead centre. Flatter honing angles cause less ring rotation and steeper angles cause higher ring rotation rates. The ring rotation is also dependent on the engine speed. 5 to 15 rotations per minute are realistic rotation figures – merely as an indication of the quantity of ring rotations.

With two-stroke engines, the rings are secured against twisting. This also prevents rebounding of the joint ends in the gas channels. Two-stroke engines are mainly used in bicycles, garden equipment and similar. The uneven wear on the rings resulting from the prevented ring rotation, the possible coking in the ring grooves and the reduced service life are accepted here. This type of application is designed for a shorter engine service life anyway. On a normal four-stroke vehicle engine used on the road, significantly higher requirements are placed on the mileage.

The twisting of the ring joints towards each other by 120° during installation is merely intended to ensure better start-up of the new engine. During subsequent operation, every conceivable position of the piston rings is possible within the ring groove if the rotation is not prevented by the design (two-stroke engines).

AXIAL MOVEMENT

Ideally, the rings should be in contact with the bottom groove side. This is important for the sealing function, as the rings do not only seal on the piston ring sliding surfaces, but also on the bottom ring sides. The bottom groove side seals the ring against gas or the passage of oil on the rear side of the ring. The sliding surface of the piston ring seals the front side to the cylinder wall (see from chapter 1.6.6 Piston ring sealing faces).

The upstroke and downstroke of the piston and the reversal of direction cause inertial forces to act on the rings, causing the rings to lift off the bottom groove side. An oil film within the groove dampens the lifting off of the piston rings from the bottom groove side caused by the centrifugal forces. Problems here occur mainly when the ring grooves have been expanded due to wear, resulting in an excessively large ring height clearance. This causes the ring to lift off its contact surface on the piston and leads to ring flutter emitting mainly from the joint ends. The sealing effect of the piston ring is lost and oil consumption increases. This is the case in the intake cycle in particular, if the downstroke of the piston and the resulting vacuum in the combustion chamber lifts the rings off the groove base and the oil is sucked past the rear side of the ring into the combustion chamber. In the other three cycles, the pressure from the combustion chamber presses the rings onto the bottom ring side.

RADIAL MOVEMENT

Basically, the rings do not move radially backwards and forwards, but rather the piston completes a change of bearing surfaces from one cylinder wall to the other in the cylinder bore due to the reversing movement. This takes place in both the top and the bottom piston dead centre. This leads to the radial movement of the ring within the piston ring groove. A forming carbon layer is thus ground off (particularly on keystone rings) and ring rotation occurs in conjunction with the cross-hatch.

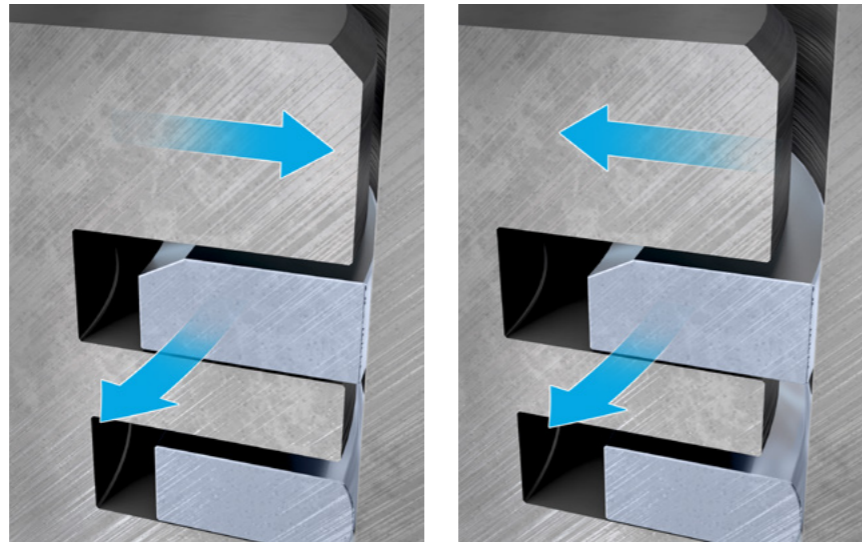

Radial movement of the piston ring

RING TWIST

The rings are moved as a result of inertial forces, ring twisting and the ring height clearance – as shown in the figure. As described in chapter 1.5.5 Crowned sliding surface shapes, the piston rings run in a crowned shape over time.

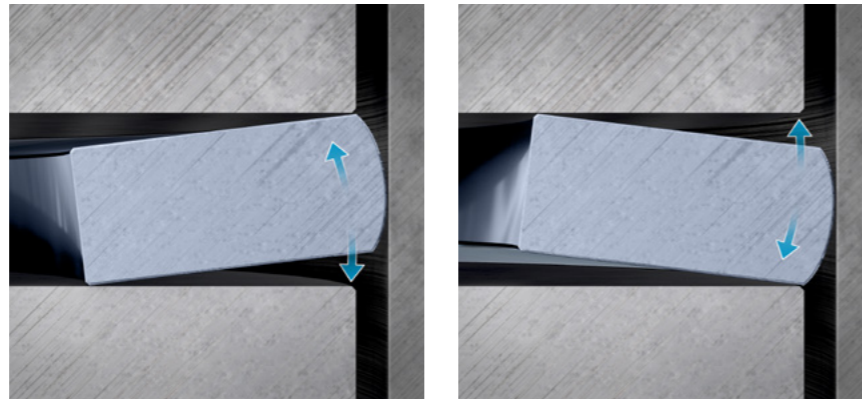

Ring twisting

2 INSTALLATION AND SERVICE

2.1 ASSESSMENT OF USED COMPONENTS

As part of a sealing system consisting of pistons, cylinders, engine oil and piston rings, piston rings can only fulfil their tasks to the extent that the function of the other components will permit. If the efficiency of a sealing component is reduced due to wear, the overall efficiency of the sealing system is reduced as a result.

The suitability for reuse of piston ring interacting sliding parts that are already run in (pistons and cylinders) should be assessed carefully. The sealing system is only as good as the weakest component in it. It is therefore not appropriate to recondition an engine merely by replacing piston rings. If the rings are worn, it can be assumed that the interacting sliding parts of the piston rings are also worn. Merely replacing the rings and reusing a worn piston or worn cylinder liner will not deliver the desired results. Remedying loss of power or excessively high oil consumption in this way is therefore a futile undertaking and will only be successful over the short term, if at all.

The causes at the heart of this state are described in chapter 1.6.6 Piston ring sealing faces, among others.



2.2 ASSESSMENT OF USED PISTONS

2.2.1 MEASUREMENT AND ASSESSMENT OF THE RING GROOVES

If new piston rings are to be pulled on to pistons that have already been run in, the ring height clearance determines whether the piston can be reused. The relevant piston ring is inserted in the cleaned ring groove as shown in Fig. 1 and measured with a feeler gauge. If a new piston ring is to be measured in a run-in piston, the method shown in the figure is better than mounting the piston ring on the piston. Pulling the piston ring repeatedly on and off the piston may cause material deformation on the piston ring, which impairs the function.



Fig. 1: Measuring the ring height clearance

⚠ ATTENTION

The wear dimension refers to the outer edges of the ring groove to be measured, i.e. it must not be possible for the feeler gauge with a thickness of 0.12 mm to be pushed between the piston ring and ring groove as shown in Fig. 2. In this case, the ring groove is classed as already worn.

| Ring height clearance (mm) | Suitability of the piston |
|----------------------------|---|
| 0.05-0.10 | ✓ Pistons can be used |
| 0.11-0.12 | ! Increased caution is required |
| > 0.12 | ✗ Piston is worn and has to be replaced |

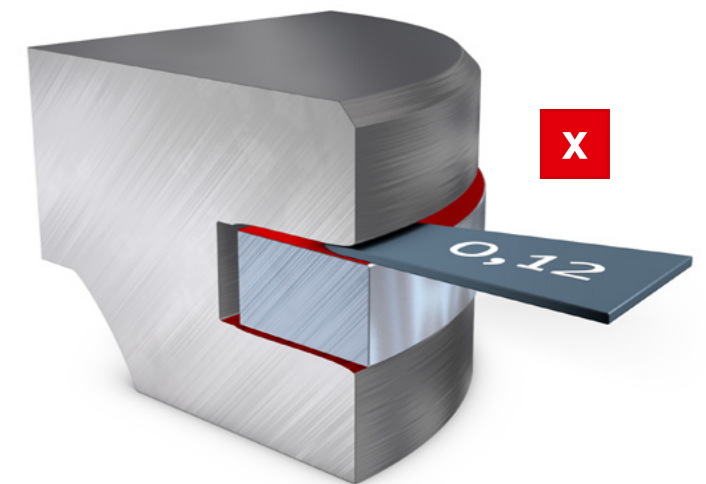

Fig. 2: Worn ring groove

It is not possible to check the ring height clearance on keystone rings in pulled-on and untensioned state. Due to the keystone shape, the correct ring height clearance is only achieved in the keystone groove if the piston ring is pressed together on the cylinder dimension or mounted in the cylinder.

This means that a measurement is difficult. For this reason, the inspection must be restricted to a visual inspection of the groove for wear (Fig. 3).

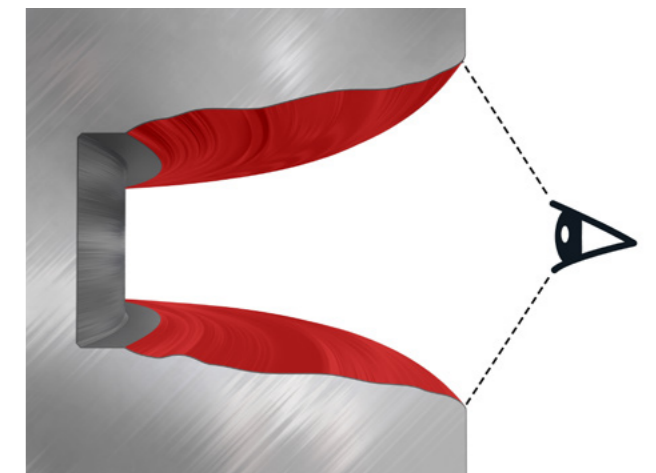

Fig. 3: Visual inspection of the groove

2.3 ASSESSMENT OF USED CYLINDER BORES

2.3.1 BRIGHT RUNNING SURFACE OF THE CYLINDER LINERS (GREY CAST IRON CYLINDERS)

Bright, ultra-smooth cylinder surfaces which no longer have any honing grooves are either the result of natural wear or a long service life or, after a short service life, are caused by dirt and mixed friction.

The fact that all honing grooves have been removed due to wear is a reliable indication that a cylinder bore is worn. Re-measuring with suitable measuring equipment is not necessary. Such cylinders should always be replaced (cylinder liners) or freshly drilled and honed (engine blocks).

Localised bright spots on the cylinder sliding surface after a relatively short service life (the honing structure has also been completely removed in this area) are an indication that mixed friction and increased wear in the cylinder has occurred in the area with the bright spots. There are two main causes for localised bright spots such as these.

2.3.2 LOCALISED BRIGHT SPOTS DUE TO CYLINDER DISTORTIONS

Cylinder distortions result in irregularities at indefinite points within the cylinder (Fig. 1). The position of the bright spots is the same as the place where the distortion occurred. The piston rings run over these constrictions and mainly wear off material there.

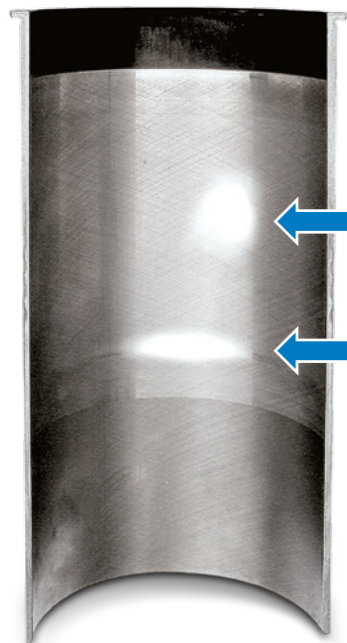

Fig. 1: Localised bright spots

At the raised points in the constrictions, inadequate lubrication and mixed friction occurs as the piston ring slides over, combined with intermittent contact with the cylinder wall.

Causes include

- Thermal distortions due to localised overheating – caused by poor heat transfer (soiling) to the cooling agent
- Failure to observe the specified tightening torque, use of incorrect O-rings or other distortions due to tightening

Remedy

- Thorough cleaning and reworking where necessary of the cylinder counter bore for wet and dry cylinder bores
- Exact compliance with the tightening specifications when mounting the cylinder head
- Regular cleaning of the cooling fins of air cooled cylinders
- Ensuring correct function of the cooling system (circulation speed, cleanliness)
- Use of the specified sealing rings (dimensions, material composition)

2.3.3 BRIGHT AND POLISHED AREAS IN THE TOP CYLINDER AREA (BORE POLISHING)

There are bare points in the top area of the running surface of the cylinder liner run over by the top land (Fig. 2). This is due to hard deposits on the top land caused by irregular combustion, poor oil quality or low combustion temperatures as a result of frequent idling periods or part-load operation. Here, the carbon layer (Fig. 3) causes abrasive wear on the cylinder wall, damages the oil film, causes mixed friction, increased piston ring wear and high oil consumption.

Remedy

- Correct operation of the engine
- Use of the specified oil qualities
- Use of branded fuel
- Correct maintenance, inspection and adjustment of the fuel injection system



Fig. 2: Bright and polished areas in the top cylinder area



Fig. 3: Carbon layer on the top land

2.3.4 TOP RING REVERSAL BORE WEAR

Top ring reversal bore wear (Fig. 1) occurs after a long service life on the turning points of the piston rings in the top and bottom top dead centre. In this area, the piston speed is reduced and even comes to a standstill briefly on the turning point. This impedes the lubricating effect, as the piston ring briefly no longer floats on the oil film due to the lack of relative speed to the cylinder wall and metal contact with the cylinder wall occurs.

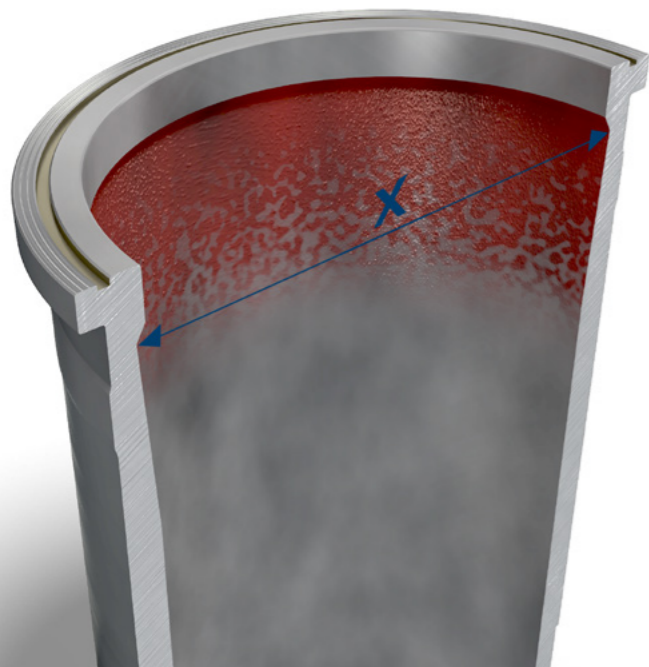

Fig. 1: Top ring reversal bore wear

The top ring reversal bore wear is largest in the piston ring turning zone close to the top piston dead centre as a result of the design, as the cylinder surface is subjected to the hot combustion here, which impedes the lubrication.

The extent of the top ring reversal bore wear determines whether the cylinder liner or engine block can be reused. If the top ring reversal bore wear exceeds the values listed in the table, the cylinder liner must be replaced or the engine block must be freshly honed. If similar levels of wear occur at a different point in the cylinder, the wear dimensions listed below obviously also apply here.

Fig. 3 shows what happens when a new piston is inserted in a worn cylinder bore. Because the new piston has no ring groove wear and the piston rings still have sharp edges, the piston ring edge hits against the wear edge of the cylinder during operation. The result is high mechanical forces, high wear and piston ring fluttering, combined with high oil consumption.

| Engine type | Top ring reversal bore wear limit "X" |
|----------------|---------------------------------------|
| Petrol engines | ≥ 0.1 mm |
| Diesel engines | ≥ 0.15 mm |

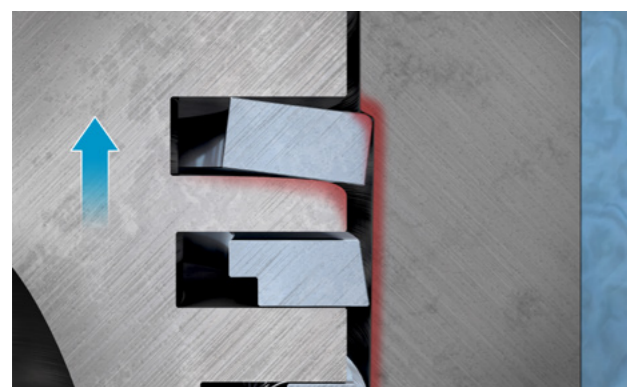

Fig. 2: Impact of the piston ring with the old piston



Fig. 3: Impact of the piston ring with the new piston

2.3.5 CYLINDER GEOMETRY AND ROUNDNESS

Perfect cylinder geometries are essential for optimal piston ring sealing. Deviations from the cylinder shape, irregularities, dimensional faults and distortions in the cylinder bores result in sealing problems on the piston rings.

This leads to increased passage of oil in the cylinder, increased blow-by gas emission, temperature and efficiency problems. These, in turn, are causes of early wear and even piston damage.

CLASSIFICATION OF CYLINDER IRREGULARITIES

Irregularities in the bore geometry are divided into levels. A perfect cylinder bore with no irregularities or form deviations in axial direction is classed as a stage 1 bore. Oval bores, which are often caused by machining faults or poor heat dissipation, are known as stage 2 irregularities. Stage 3 triangular irregularities are mainly the result of a superposition of stage 2 and stage 4 distortions. Stage 4 irregularities, i.e. square shape faults, are usually caused by distortions resulting from the tightening of the cylinder head bolts.

The extent of the irregularity can fluctuate between zero and several hundredth of a millimetre. Due to low piston installation or piston-to-wall clearances on some engines, distortions of more than a hundredth of a millimetre (0.01 mm) may therefore already be too much. Piston rings are only capable of reliably sealing minor stage 2 irregularities, i.e. slightly oval cylinder bores and slight keystone shapes in axial direction. Stage 3 and stage 4 irregularities, as are often created by screw distortions and/or machining faults, can quickly bring the piston rings to the limits of their sealing function.

Particularly with newer piston designs, where the piston ring heights are close to one millimetre or even lower, the sealing problems become increasingly pronounced with irregular cylinder bores. The design-based reduction of the piston ring heights serves to reduce frictional losses inside the engine and thus also the fuel consumption. The reduction of the contact surfaces of these rings on the cylinder wall requires a lower piston ring tension. The specific surface pressure of the rings would otherwise become too large and the tribological characteristics would become worse. If the bore geometries are correct, this design-based reduction of the piston ring tension has no negative effects. The rings seal extremely well, cause only minor frictional losses and have a high durability. With irregular and distorted cylinders, the lower piston ring tension means that the rings do not adapt or adapt extremely slowly to the cylinder wall and can therefore not fulfil their specified sealing function.

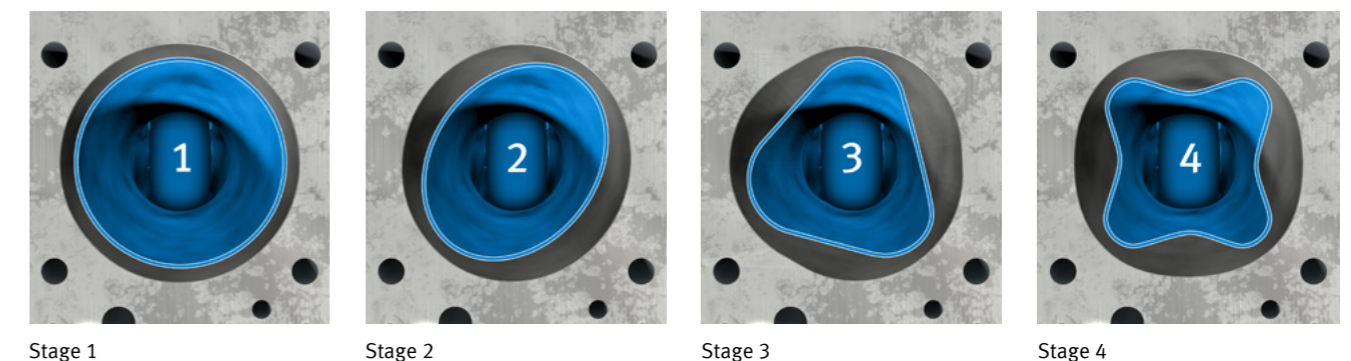

Stage 1

Stage 2

Stage 3

Stage 4

2.3.6 CAUSES OF IRREGULARITIES AND DISTORTIONS ON CYLINDER BORES

Irregularities and distortions on cylinder bores can be caused by the following:

- Thermal distortions caused during operation due to poor heat dissipation as a result of faults in the coolant circulation or, on air-cooled engines, caused by soiled, oil-contaminated cooling fins and/or ventilation problems. The localised overheating of the cylinder sliding surface occurring in the cylinder results in increased thermal expansion in this area, thus causing form deviations from the ideal cylinder shape
- Design-related thermal distortions caused by different thermal expansion during engine operation
- Thermal distortions resulting from poor lubrication and cooling during cylinder machining
- Irregularities due to excessively high machining pressures or the use of incorrect tools during honing
- Distortion due to tightening on the cylinder caused by shape inaccuracies and incorrect screw tightening

Fig. 1 is classed as a stage 4 cylinder distortion, which also occurs if the cylinder head bolts are tightened correctly as a result of the design.

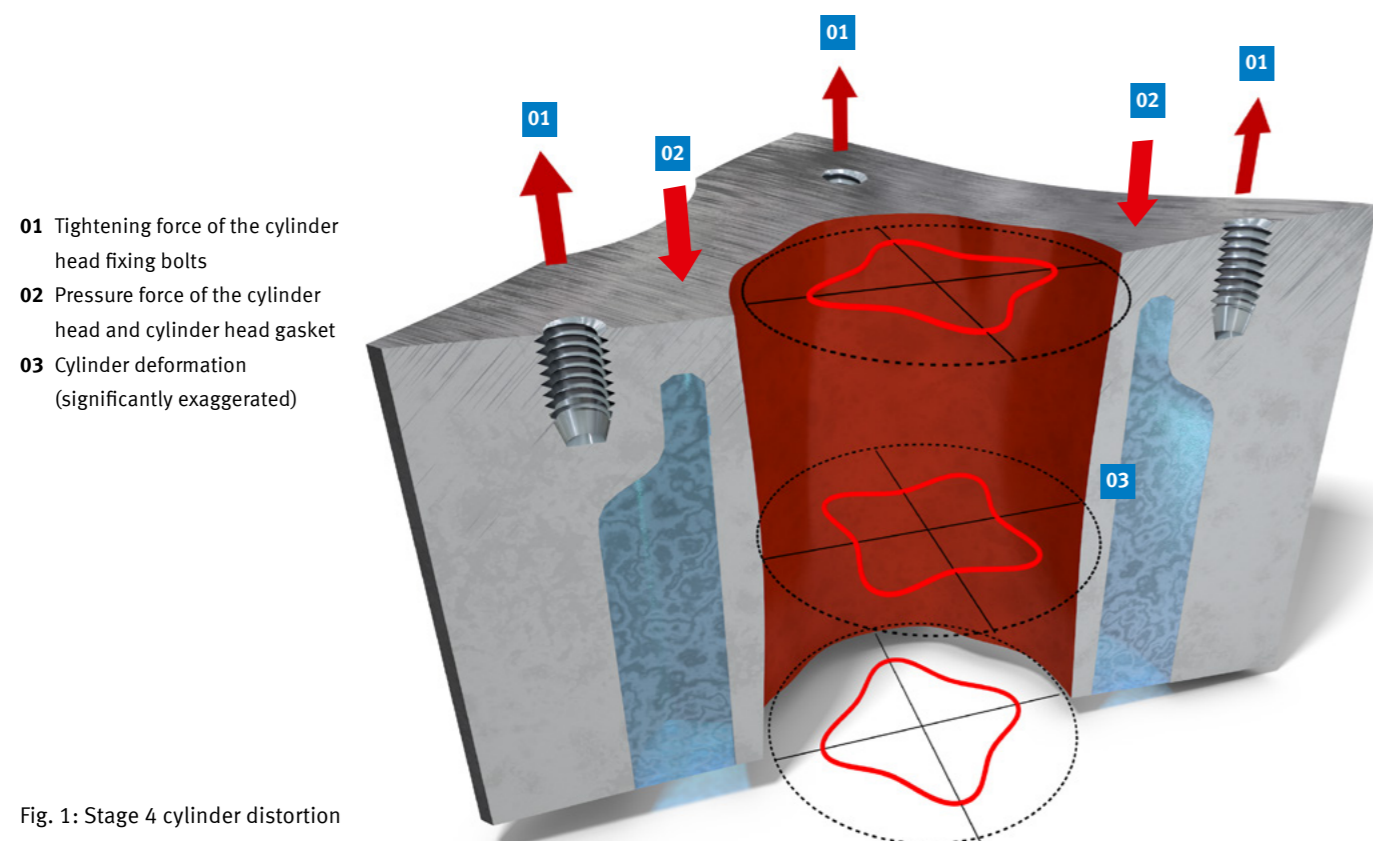

Fig. 1: Stage 4 cylinder distortion

2.3.7 REWORKING USED CYLINDER BORES

When replacing pistons or piston rings, so-called honing brushes or spring-loaded honing stones are often used in practice (Fig. 2 and 3). This machining step has little to do with correct honing, however. The more or less worn running surface of the cylinder liner is merely cleaned and roughened slightly. The cylinder geometry cannot be improved with this process. Because the grinding tools are spring-loaded, they follow every irregularity and every distortion and no improvement in the geometry can be achieved. The low contact pressure also means that it is almost impossible to achieve useful roughness values that could help to improve the lubricating effect. Only a slightly higher frictional resistance for the new piston rings is created, enabling them to adapt slightly faster to the cylinder wall. The wear present on the cylinder surface can not be reversed or improved. No lasting improvements in the cylinder sliding surfaces can therefore be achieved with honing brushes or spring-loaded honing stones – merely a slightly better appearance and a slightly shorter running-in time. This means that this method can not be regarded as a repair or reconditioning method.



Fig. 2: Spring-loaded honing stones

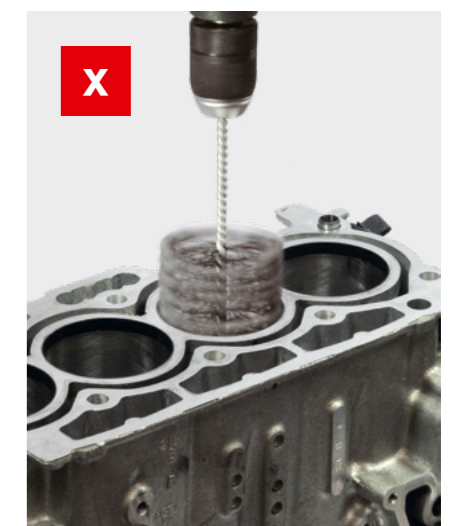

Fig. 3: Honing brushes

2.4 PISTON AND PISTON RING ASSEMBLY

The biggest piston ring problems and damage occur as a result of the rings being pulled incorrectly on to the pistons. This is where the piston ring is subjected to the highest mechanical strain. Pulling on the rings incorrectly has a negative impact on the contour and radial pressure distribution of the ring created during production. The desired sealing function is therefore only partially achieved or may even no longer be achieved at all.

A piston ring may only be spread far enough so that the inside diameter can be brushed over the outside diameter of the piston. Further spreading results in distortion of the ring, particularly on the back of the ring (Fig. 1), causing significant sealing problems in installed state.

Breaks, detachment of coatings (particularly on rings filled with molybdenum), reduced pressure forces on the back of the ring, through to crescent-shaped gaps (Fig. 2) are all problems that impair the function of the piston ring or cause it to fail completely.

ATTENTION

Never bend the piston rings up to increase the tension! When the joint ends are pulled apart, the ring only bends in one place – at the back of the ring. The ring tension can not be increased in this way. Quite the opposite: If the ring is bent up or bent out of shape excessively, the ring loses its round shape and can no longer seal correctly.



Fig. 1: Excessive spreading of the piston ring

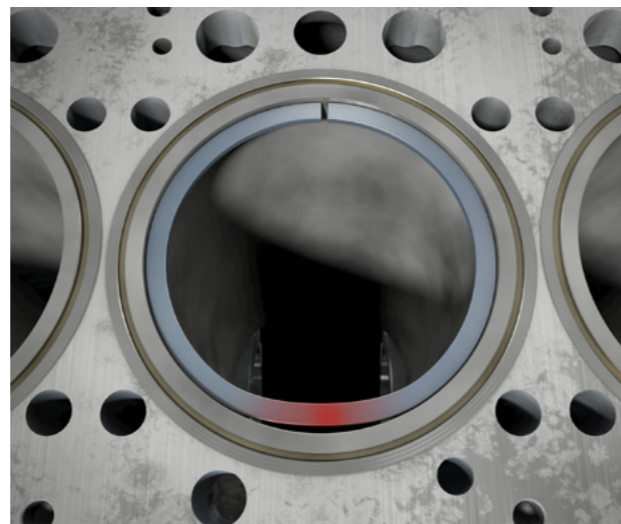

Fig. 2: Formation of crescent-shaped gaps due to excessive spreading

2.4.1 MOUNTING AND DISASSEMBLING PISTON RINGS

- Clean used pistons carefully to remove stuck-on dirt. Ensure in particular that the ring grooves are free from carbon and dirt. If necessary, clean oil drainage bores with a drill or other suitable tool.
- Take care not to damage the groove sides when removing carbon. The bottom groove side is a sealing area. Damage due to scratches can cause high oil consumption or increased blow-by gas emission during engine operation.
- Always use piston ring pliers for mounting and dismantling piston rings. Other tools, such as wire loops or screwdrivers, damage the piston ring and the piston.
- Never pull on the rings by hand (exception: steel cup segment type double bevelled oil control rings). There is not only a risk of the ring breaking, bending and being subjected to excessive strain, but also the risk of injury when the ring breaks or due to sharp ring edges.

ATTENTION

Pulling on the piston ring quickly by hand without breaking it may demonstrate the skill of the mechanic, but usually also damages the piston ring during the mounting stage.



Piston ring mounting set

Item no. 12 00001 16 900 (passenger cars)

Item no. 12 00002 16 900 (utility vehicles)



- Never pull the ring over the piston in the way shown. If the ring bends and no longer lies flat in the groove, it will no longer rotate in the groove, becomes worn on one side or no longer seals correctly. Even worse for rings with a molybdenum coating, however, is flaking or breaking of the molybdenum layer. If the loss of the sliding layer does not occur during installation, then it will definitely happen during engine running. The sliding layer comes loose, damages the piston and cylinder and the piston eats away the cylinder bore, because hot combustion gases blow through between the piston and the cylinder wall. The loose parts lead to damage on the piston and cylinder sliding surfaces.
- Avoid pulling the piston rings on and off unnecessarily. The rings bend slightly during each mounting. Do not pull off the rings of pre-assembled pistons to measure them, for example.
- Observe the installation sequence of the rings: First mount the oil control ring, then the second compression ring, followed by the first compression ring.



- Check whether the ring disappears completely into the ring groove over the entire circumference, i.e. the sliding surface of the ring must not protrude over the piston skirt. This is important because, if there is no groove base clearance (incorrect ring or groove base carbonised), the ring function is not guaranteed.

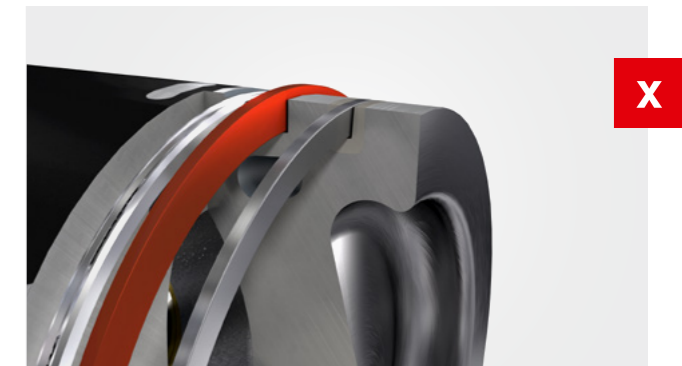
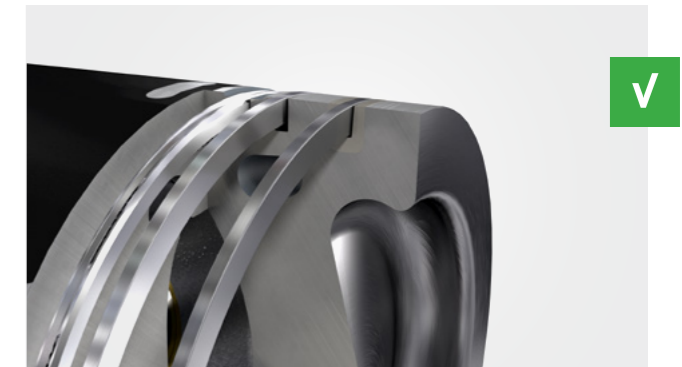

- Observe the installation markings. "Top" means that this side must point upwards to the combustion chamber. If you are unsure or if no "Top" mark is present, mount the ring with the writing pointing upwards.



- When installing two-part oil control rings, always note the position of the spiral expander. The ends of the spiral expander must always be opposite the ring joint.



- Check whether the rings can be freely (turned) rotated in the ring grooves.



- With three-part rings, the correct position of the expander spring is essential to guarantee the oil scraping function. Before the piston installation, always check the position of the expander springs even with pistons with pre-assembled rings. During transport the spiral ends are untightened and can slip one above another. Both colour markings at the spiral ends must be visible. If they are not visible, the spiral has overlapped and the ring is not working. All ring joints of the three-part oil control ring (the two steel rails and the expander spring) must be turned against each other by 120° each.

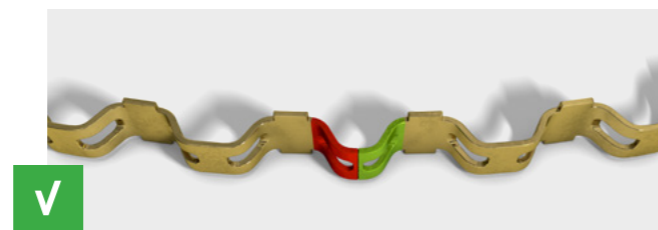
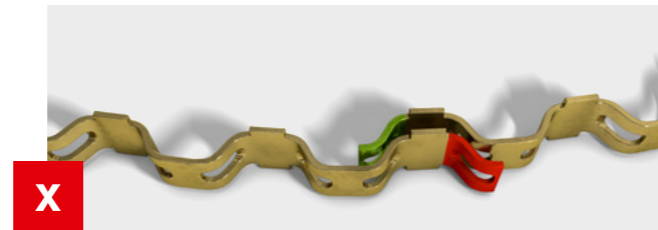

- Turn the piston ring joints of the installation-ready piston so that the piston ring joints are turned roughly 120° towards each other. This helps the piston or the piston rings during the first engine start. Reason: The compression is slightly lower during the first engine start, as the piston rings are not yet run in. Turning the joint ends towards each other prevents too much blow-by gas from being created during the first engine start, causing the engine to start up poorly.



2.4.2 INSERTING THE PISTON INTO THE CYLINDER BORE

- Clean the sealing area of the engine block thoroughly of fragments of gaskets if it was not reworked during the reconditioning.
- Clean all tapped holes carefully from dirt, oil and coolant agent which may still be there.
- Carry out all cleaning work before installing the pistons in the cylinder.
- Wet all surfaces on the piston with fresh engine oil – do not forget the piston pins and connecting rod bearings.
- Note the direction of installation of the piston (installation markings on the piston crown, valve pockets).
- Clean the cylinder bore again with a cloth and also wet this with engine oil.
- Check your piston ring scuff band for damage and dents and remove them or replace the tool if necessary.
- During piston installation, ensure that the piston ring clamp or the conical assembly sleeve lies flat on the cylinder head sealing face.
- Do not install the piston in the engine without using a fitting tool (risk of injury, risk of ring breakage).





Fig. 1: Chamfer on the cylinder bore too large – the piston rebounds between the piston ring scuff band and cylinder during mounting and the piston becomes blocked

- A large amount of pressure must not be necessary when installing the piston. If a piston cannot be pushed into the cylinder, always check the piston ring clamp. Do not turn the opening of the clamp so that it lines up with the joint ends of the rings.
- When using a hammer handle for installation, only the weight of the hammer may act on the piston crown. Never use the hammer to drive the piston into the cylinder with force. If the piston rings do not break during installation, they can still be bent and can no longer fulfil their function completely later during engine running.
- Installation using force not only damages the rings, but can also damage the piston. This is particularly the case for pistons in petrol engines. On these engines, the top and ring lands are extremely thin in some cases and may crack slightly or break through with an impact load. The result is loss of power and expensive repairs in the short-term.
- Avoid dirt and sand falling in to the cylinder after the pistons have been inserted. Where necessary, place or insert clean cloths on/in the bores to prevent avoidable dirt contamination. Particularly when working in dusty environments and/or in open air.



Fig. 2: Small chamfer on the cylinder bore – the piston ring slides over the gap

2.5 ENGINE INITIAL START-UP AND RUNNING-IN

2.5.1 GENERAL

When we talk about engine running-in, we usually think about all the moving components that have to adapt to each other. This is correct in general, but is particularly true of piston rings. Piston rings are the components that are subjected to the highest level of stress due to their tasks and not only have to adapt to the surface of the associated part, but must also seal perfectly. The piston rings are therefore the components that benefit most from a correct and good running-in process. All components supplied with pressure oil do not have to contend with the same high levels of stress during running-in as the piston rings.

Customers and mechanics often have different opinions regarding the approach to the initial start-up and running-in of reconditioned engines. Many believe that a running-in period of between 500 and 1,500 km is still necessary, while others believe that no running-in period is required at all. The latter opinion is based largely on the information from a number of engine manufacturers, who do not plan for a specific engine running-in period. Both opinions are correct and justified in their own right. We merely have to differentiate between new and reconditioned engines.



2.5.2 RUNNING-IN NEW ENGINES

Today, new engines are produced using state-of-the-art production methods. The interacting sliding parts are manufactured so precisely that the adaptation that previously took place during the running-in time of the engine has already taken place on the components in special manufacturing processes. This takes place in special manufacturing processes (e.g. for running surfaces of the cylinder liners), as well as through precision machining of the remaining interacting sliding parts. This mainly involves lapping processes to free the surfaces from the ultra-fine burrs and surface unevennesses created during the machining processes. Previously, the adaptation process was carried out by the interacting sliding parts, which had to adapt to each other during the running-in time. This involved a significant loss of material. Pistons rings lost a significant portion of their wear reserves as early as the first hours of operation, for example. Particularly in today's climate, where every milligram of emissions is fought over, engines are required to comply with their defined fuel consumption figures and the emissions limits from the very start.

An engine running-in phase, where the sliding surfaces have to adapt to each other first through friction and above-average wear, is therefore hardly conceivable at all in modern engine manufacture.

After all, the end consumer expects an engine performance that is significantly higher than what was classed as optimum 25 years ago. Last but not least, a new vehicle from the factory has completed a veritable cold start marathon by the time it has passed through the various logistics centres and transports and arrived at the customer. An engine often has to withstand 150 cold starts without ever reaching operating temperature in between. Also consider ship transport to other countries and continents. An engine that still had to be run in would obviously have a bad start in life under these conditions.

Another reason for the more relaxed running in instructions for new vehicles from the factory is the fact that, due to the current levels of traffic on the roads, vehicles are hardly ever run to their maximum performance limits. Even on motorways with no speed restrictions, it is rarely possible to reach the vehicle top speed or rated output of the engine for any length of time. A driver who used to travel briskly with a 30 kW vehicle and with a low achievable top speed was able to run the vehicle at full load for extended periods even on normal roads.

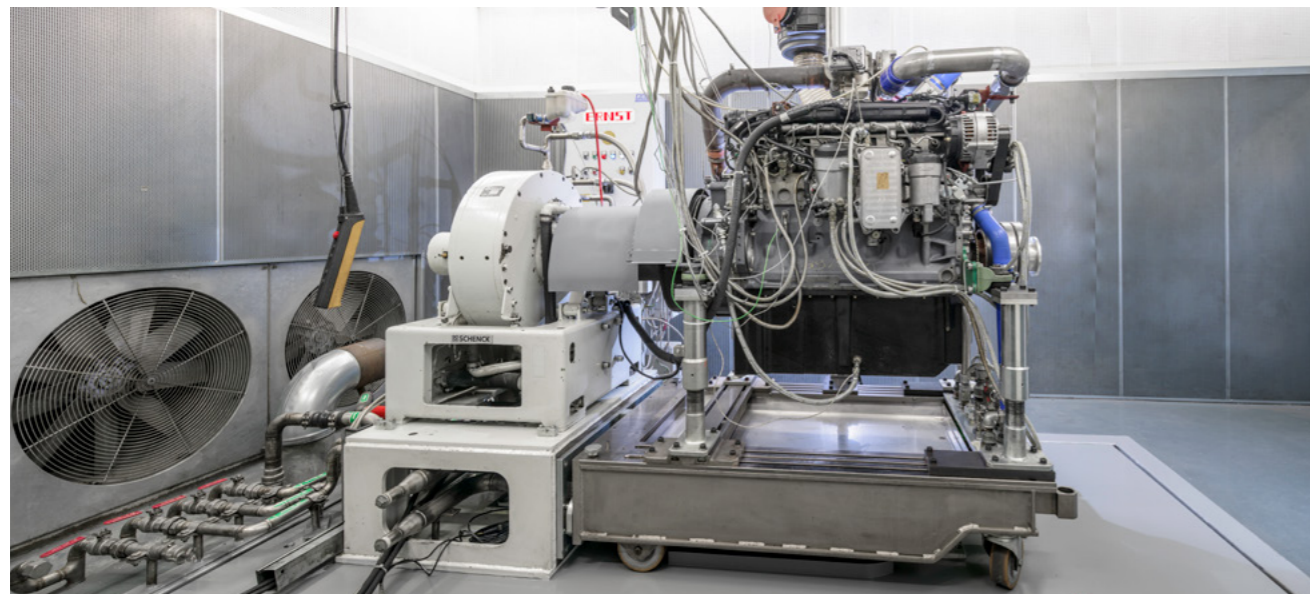

Running-in and wear tests on the engine test rig

2.5.3 RUNNING-IN RECONDITIONED OR REPAIRED ENGINES

In contrast to new engines from the factory, running-in is required for reconditioned engines where new cylinder liners have been used or where the cylinder bores have been bored and honed to the next oversize. In practice, the engine reconditioner (depending on the available machine fleet and equipment) can not always work as precisely and dirt-free as during the initial production at the manufacturer.

Reconditioning does not restore used engines to their new state. New and used parts are often combined and engines are frequently not consistently and completely overhauled for financial reasons. Running-in is most needed if cylinder bores, cylinder heads or crankshafts are reworked. In practice, it is often not possible to achieve the same machining parameters as in the first production, as the values are often unknown or the machines available only permit standard machining. For these reasons, it is advisable to comply with the running-in instructions outlined below for reconditioned engines.

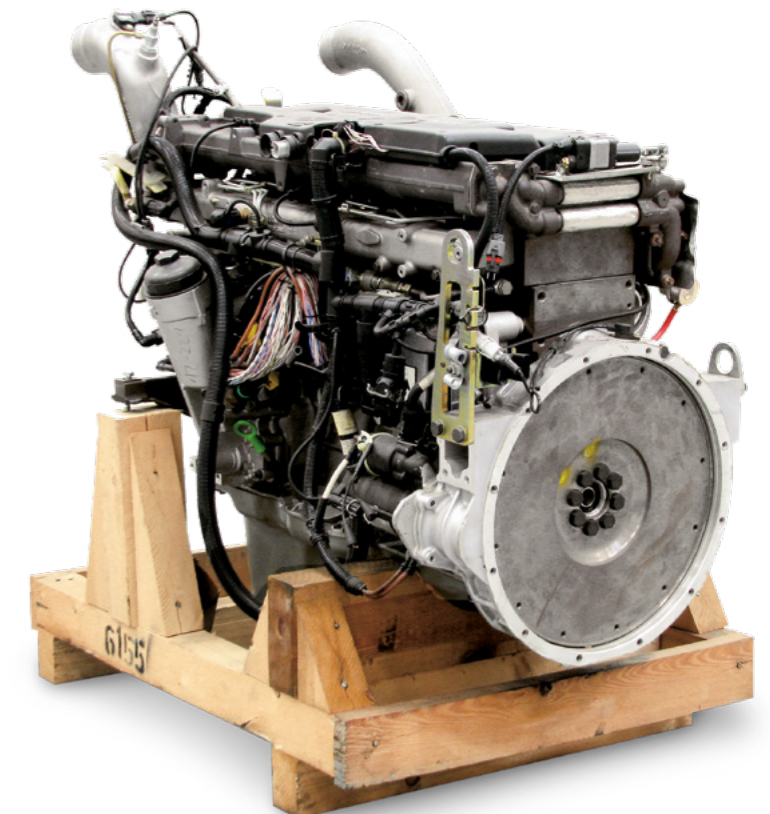

2.5.4 RUNNING-IN RECOMMENDATIONS FOR RECONDITIONED ENGINES

- Always run the engine in on the road or on an engine test rig
- The vehicle should not be fully laden
- Run the engine at constantly changing speed levels not exceeding 2/3 of the maximum speed
- While driving, move up the gears quickly, avoid underrevving, avoid maximum gear speeds
- Avoid lengthy uphill driving (excessive load)
- Avoid lengthy downhill driving (insufficient load and undesirable overrun condition)
- Do not use engine braking systems
- Drive on motorways or at top speed – avoid driving in congested traffic
- Driving on open roads and in free-flowing urban traffic is best – however, avoid driving in towns at extremely high temperatures and in the rush hour with frequent stops at traffic lights and hold-ups

ATTENTION

Running in instructions are available for vehicles new from the factory. The same also applies for reconditioned engines. The engine must be run in on the road if no test rig is available for implementing a defined running-in program.

CONSTANT OIL LEVEL MONITORING DURING THE RUNNING-IN PHASE

The oil consumption may be higher during the running-in phase. It is advisable to check the oil level every 50 to 100 km and to top up the oil if necessary. In the event of a noticeable drop in the oil level on the oil dipstick, continue to check at shorter intervals. Do not overfill.

OIL CHANGE AFTER 1,000 KM

Although it has long been the case that no oil change is required after the first 500 to 1,000 km for modern engines in new vehicles from the factory, it is still advisable for reconditioned engines. Dirt from the previous engine damage or reworking of various parts is often still present in the oil circuit of the engine. Added to this is the abraded metal resulting from the run-in processes on the renewed engine parts. These wear-promoting impurities must be removed with an oil change after the run-in process.

ATTENTION

During this oil change, the oil filter must also be replaced.

ATTENTION

Hour-long engine operation at idling speed is extremely harmful for the engine.

An engine does not run in at idling speed. In fact, the opposite is true - it can even be damaged. In idle mode, the bearings and the pistons receive a poor supply of oil. The lubrication is called into question, as the oil pump transports little oil at idle speed. The oil flow through the bearings is minimized at an inopportune moment. Right when the adaptation processes of the components generate increased heat build-up through frictional heat, there is insufficient oil for lubrication and cooling.

Oil supply channels and lines may not be vented and flushed correctly due to the lack of oil flow. Metal abrasion, residual dirt from the reconditioning or previous damage that is still in the oil supply system is not flushed quickly enough out of the engine bearings and washed off the cylinder wall. It remains at the inlet point and already causes renewed wear there.

And let's not forget the fuel system. Particularly on diesel engines with new or reconditioned injectors, it is important that they are flushed through correctly. The fuel quantities injected during idling are extremely small, however. A slightly stiff injector nozzle needle may also not open or may not atomise the fuel correctly.

2.6 SEALING PROBLEMS AND PISTON RING DAMAGE

2.6.1 SKEWING OF PISTONS

Engine damage frequently also causes bending/twisting of the connecting rods. If the big and small connecting rod eyes are not checked for parallelism during reconditioning or if the connecting rod is not aligned straight, skewing occurs on the piston in the cylinder during subsequent engine operation. The piston rings will not run in a true circle in the cylinder, but will trace an elliptical pattern. This causes severe sealing problems. The piston rings will make contact at the bottom on one side and at the top on the other side of the cylinder. If the ring is still able to turn in the ring groove, it will be crowned in just a short time. This crowning significantly exceeds any level of crowning desired as a result of the design, so that the lubricating film becomes much thicker and makes good oil scraping performance impossible. As the piston is skewed, a pumping force will also be applied to the piston rings resulting in the increased ingress of oil into the combustion chamber.

Frequently, the skewing also means that the piston rings are unable to turn and deflect into an elliptical form. This causes uneven radial wear, which often results in the piston rings breaking.

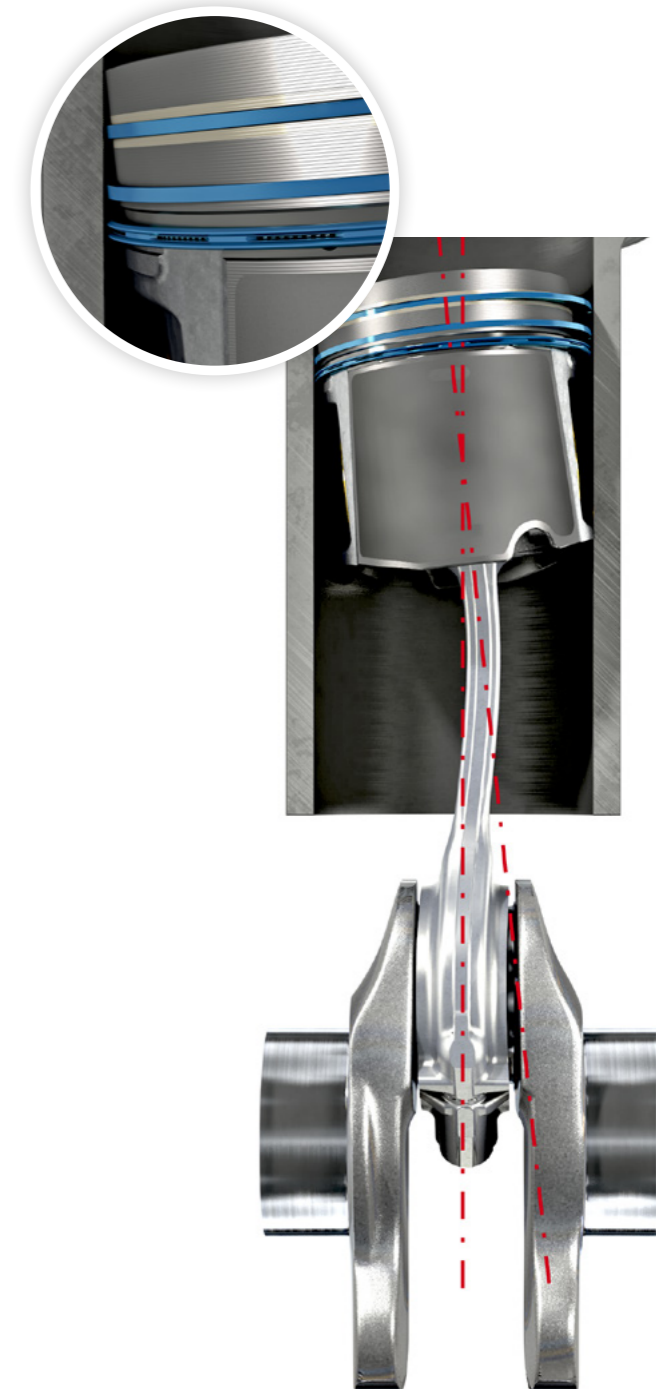

2.6.2 OVAL BORE

In cylinders with oval bores, the lower piston ring tension means that the rings do not adapt or adapt extremely slowly to the cylinder wall and can therefore not fulfil their specified sealing function.

2.6.3 RING JAMMING AND ROTATION OBSTRUCTIONS

Sealing problems often occur when the rings on four-stroke engines can not move freely in the ring grooves. This inevitably causes damage on the pistons and cylinders (overheating and piston seizures). Keystone rings (see chapter 1.3.1 Compression rings) are less prone to ring sticking or blockages in the ring grooves due to their shape.

Reasons for ring blockages and ways to prevent them

- The rings must not clamp axially in the groove. The evenness of the piston rings must be guaranteed. Take care not to bend the piston rings by pulling them onto the piston incorrectly (see chapter 2.4.1 Mounting and disassembling piston rings).
- The dimensions of the ring groove must match the piston ring.
- The ring grooves must be free from dirt and other deposits (Fig. 1).
- The engine oil must meet the specifications stipulated by the engine manufacturer. Incorrect oil promotes the formation of carbon deposits and ring sticking in the grooves.
- Operation of the engine with vegetable oil and alternative fuels.
- Bent connecting rods and consequent skewing of the pistons in the cylinder bore.



Fig. 1: Dirt deposit in the ring groove

2.6.4 DIRT

Intake of dirt in the engine is one of the most frequent reasons for early wear on the engine and, consequently, also on the piston rings. There are two principal causes of dirt damage:

Cause 1

The dirt is transported into the cylinder with the intake air. This always happens when the air filter maintenance is not carried out correctly. If the vehicle is driven without an air filter or if there is a leak in the intake system and the dirt enters the combustion chamber past the air filter. The dirt in the combustion chamber also enters the piston ring grooves, where it combines with the oil to form an abrasive paste (Fig. 2). The height of the piston rings is ground down in this case and the piston ring grooves are expanded (Fig. 3). The wear caused by the dirt on the piston rings mainly acts on the ring sides in axial direction. In radial direction (on the sliding surface), the ring also wears due to the resulting mixed friction, but nowhere near as much as on the sides. Roller marks on the ring sides are a frequent indication of dirt in the ring grooves. The dirt, which consists mainly of fine sand, in conjunction with the rotation of the rings and the piston rocking motion, scratches characteristic patterns into the ring side.

Because the rings are mainly in contact with the bottom groove side during operation, the wear mainly occurs on the top ring side. This is also where the roller marks are found (Fig. 4 and 5).

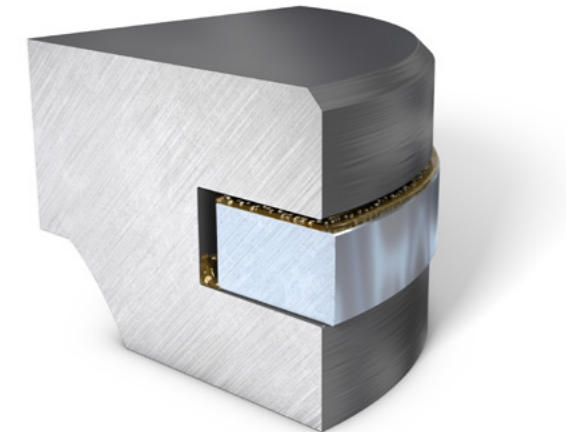

Fig. 2: Dirt and oil deposits in the ring groove combine to form an abrasive paste.

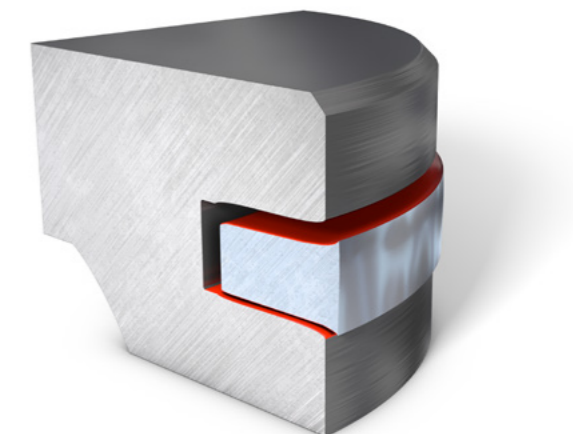

Fig. 3: Piston ring groove expansion through ground down piston ring

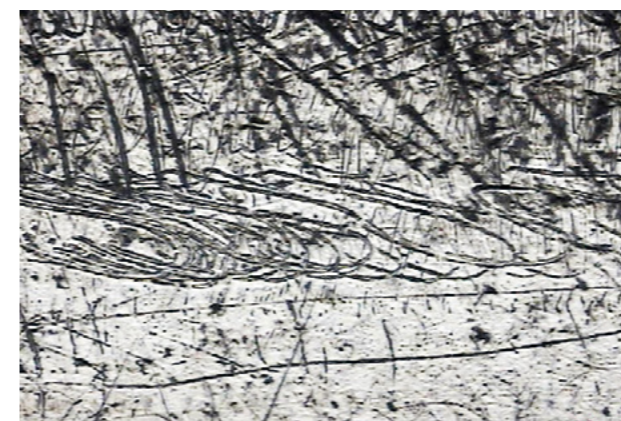

Fig. 4 and 5: Examples of roller marks on the top ring side

Cause 2

The dirt is still in the oil circuit as a result of previous damage and/or a poorly carried out repair/reconditioning. The dirt then starts to wear on the cylinder walls and pistons from the crankcase. Dirt particles also reach all bearing positions in the engine via contaminated oil circuits. Although the oil is filtered via the oil filter, the oil circuit is frequently not cleaned correctly. Dirt that is already on the clean side of the oil circuit reaches the bearing positions and results in premature wear or damage.

In the event of engine damage, the oil filter is often so heavily blocked through abrasion that the bypass valve opens. In this case, the engine oil reaches the lubricating points unfiltered. These facts are accepted in the engine design to prevent major engine damage due to complete oil loss on the bearings. Following engine damage, there are often still large amounts of dirt in the oil cooler and in its oil lines. It is therefore irresponsible to connect a new or reconditioned engine to an uncleaned oil cooler and run the engine.

2.6.5 FUEL FLOODING

After damage due to dirt, damage and wear caused by fuel flooding is the second most common cause of damage on piston rings. In the event of fuel flooding, the oil film on the cylinder wall suffers so significantly that the piston rings rub metal on metal against the cylinder wall and quickly lose radial wall thickness. Metal contact between the piston rings and the cylinder wall (Fig. 1) may only occur briefly and in exceptional cases (e.g. during a cold start) and is not permitted in normal engine operation. The service life of pistons, piston rings and cylinder bores suffers significantly and is drastically shortened. In normal state, the interacting sliding parts are always separated from metal contact by an oil film (Fig. 2). Here, the oil film must therefore be thicker than the unevennesses on the surfaces of the interacting sliding parts.

During engine operation, combustion faults often result in an accumulation and condensation of fuel on the cylinder wall. In this case, the oil film is thinned or washed off. The resulting mixed friction causes the piston rings to wear completely within a few thousand kilometres. The performance drops and oil consumption rises.

ATTENTION

If an oil cooler is contaminated as a result of engine damage, cleaning often brings minimal success. In this case, it is better to use a new oil cooler to rule out the risk of damage resulting from using the old oil cooler.

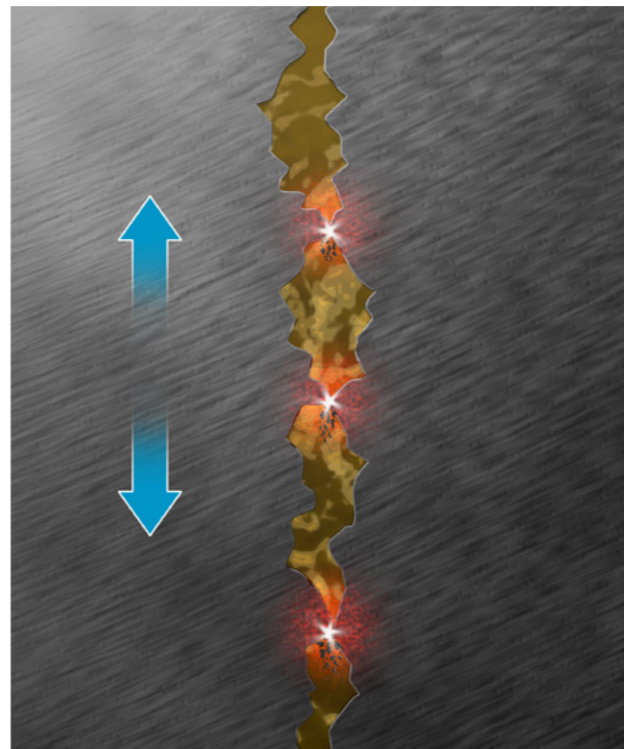

Fig. 1: Mixed friction – metal contact occurs between the piston ring and cylinder wall

Mixed friction leads to significant radial wear on the piston rings and the cylinder surface. This is clearly visible on the two scraping lands of the oil control ring. Fig. 3 shows a new oil control ring and an oil control ring worn through mixed friction. The two scraping lands are completely worn down. The engine the ring comes from suffered from excessive oil consumption. Radial wear such as this, that not only occurs on the oil control rings, can almost always be traced back to fuel flooding.

Particularly if the extent of the wear is not equal on all pistons, mixed friction wear due to fuel flooding is the only possible explanation. This situation is actually extremely common and is proof that the rings are not worn due to suspected poor material quality or faulty cylinder machining. If this were the case, the wear would occur evenly on all pistons and piston rings, can almost always be traced back to fuel flooding.

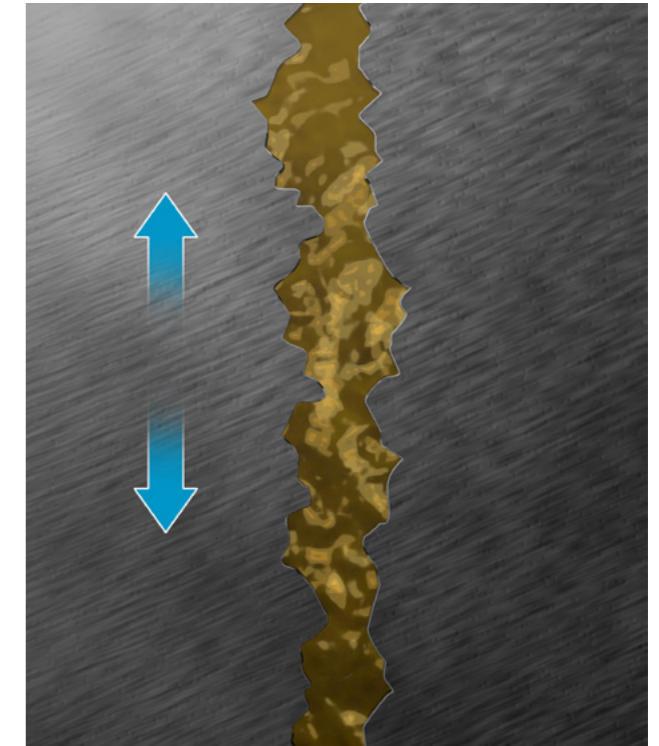

Fig. 2: Oil film with sufficient thickness – no metal contact



Fig. 3: New and worn oil control ring

Mixed friction wear caused by fuel flooding occurs on petrol and diesel engines equally.

With petrol engines, frequent short-distance drives (particularly with carburettor engines) and misfiring are the main causes. Petrol engines require a much higher fuel quantity to start up and in the warm-up phase than at operating temperature. In the case of frequent short-distance drives, the condensed and stuck on fuel on the cylinder wall may not be able to vaporise and binds with the engine oil. This leads to oil dilution and mixed friction due to the loss of viscosity in the engine oil. With petrol engines, incorrect spark plugs or ignition coils can also cause fuel flooding, as the fuel does not ignite and is therefore not burnt.

In diesel engines the injected fuel ignites when exposed to highly compressed air in the combustion chamber. Lack of compression (poor filling) or poor fuel quality result in ignition delays, incomplete combustion and liquid fuel collecting in the combustion chamber.

Further reasons for fuel flooding on diesel engines include

- Faulty and leaking injection nozzles
- Fault in the fuel injection pump or settings incorrect
- Incorrectly routed and poorly secured injection lines (vibrations)
- Mechanical faults (piston impact on the cylinder head) due to an incorrect piston protrusion dimension caused by reworking on sealing surfaces and the use of cylinder head seals with incorrect thicknesses
- Poor filling due to blocked air filters
- Poor filling due to faulty or worn turbocharger
- Poor filling due to worn or fractured piston rings
- Poor fuel quality (poor selfignition and incomplete combustion)

ATTENTION

With this type of damage too, we must differentiate between whether the wear is only present on specific cylinders or on all cylinders. If damage is present on all cylinders, it is most likely a global cause, such as poor fuel quality or poor filling. If only individual cylinders are affected, faulty injection nozzles, spark plugs or high-voltage cables are the likely potential causes.

2.6.6 PISTON RING FRACTURES

Piston ring fractures are caused either by excessive wear, ring flutter or faults during ring mounting.

Fractures during operation of the piston rings do not occur without extreme operating conditions. When pulling the rings on to the piston, the mechanical stress is much higher than during operation. When pulling on the piston rings, the piston rings must withstand significantly more bending stress than during installation in the cylinder. A ring with joint or material faults would break when pulling it on.

If broken piston rings are found in the engine immediately after a piston repair, they were usually damaged or broken beforehand by incorrect piston installation or faulty fitting tools.

Rings can break during operation after a long service life. This happens if the radial or axial wall thickness has already been reduced significantly due to wear.

The significantly increased ring height clearance usually results in ring flutter, and the ring can no longer withstand the stress acting on it. The ring usually breaks into many small pieces.

But rings don't necessarily have to have a reduced material thickness to break. If combustion faults occur during operation, rings may break due to the high stress without them being worn. Unintentional water or oil ingress in the combustion chamber can also lead to ring fractures. Liquids can not be compressed. If the quantity of liquid exceeds the volume of the compression space, the liquid must either push past the piston or break the piston or piston rings. The connecting rod may also bend or the cylinder wall/cylinder liner break.



Broken piston ring

2.6.7 RING FLUTTER

Ring flutter can occur in particular on petrol engines under medium load and at high speeds. Fluttering refers to both the lifting of the piston ring off the bottom flank contact area and the loss of sealing effect on the ring due to the loss of radial contact on the cylinder wall (collapsing). Both result in loss of power and high oil consumption, as the sealing function is impaired or eliminated completely.

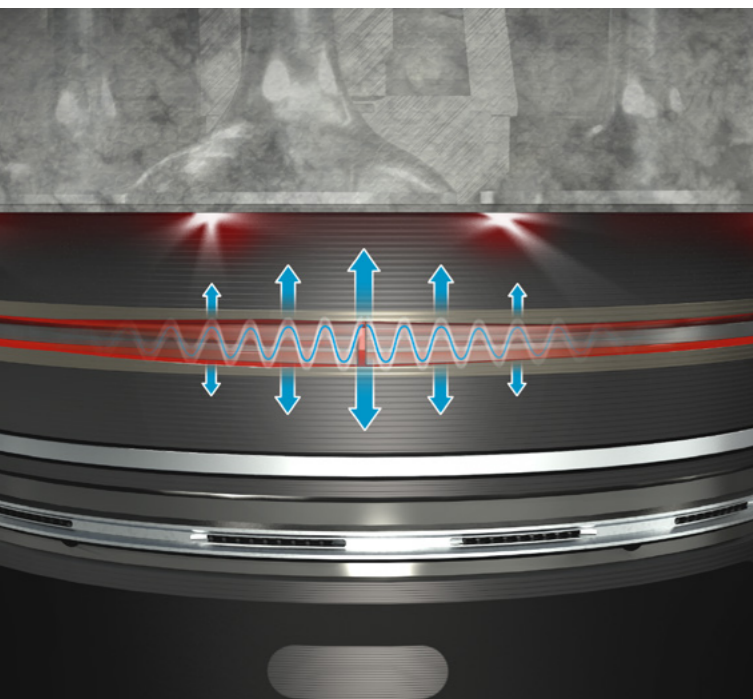

Fig. 1: Ring flutter due to mechanical contact of the piston and cylinder head

AXIAL RING FLUTTER

Axial ring flutter is usually initiated in the ring from the joint ends. Due to their exposed position, the joint ends are particularly susceptible to lifting off the bottom contact surface under unfavourable conditions. The joint ends set into vibration then transfer the vibration in waves over the entire piston ring.

ATTENTION

Due to the lower inertial force, low ring heights have less tendency to flutter. Higher contact pressure on the joint ends counteracts the tendency towards fluttering.

Reasons for axial ring flutter

- Excessive ring height clearance
- Loss of ring tension (wear), resulting in poor pressure behaviour on the joint ends, particularly with piston rings with pear-shaped radial pressure distribution (see also chapter 1.6.2 Radial pressure distribution)
- Mechanical contact of the piston with the cylinder head due to reconditioning errors, particularly on diesel engines (Fig. 1)
- Knocking combustion due to errors in the engine management (mixture formation, ignition) and due to inadequate fuel quality (octane rating too low, diesel admixtures)
- Worn piston ring grooves
- Groove base gas volume too low due to carbon deposits in the groove base (cause: combustion temperatures too high) and/or inadequate engine oil grades

RADIAL RING FLUTTER

An excessive increase in the gas pressure on the piston ring sliding surface during combustion (Fig. 2) disturbs the balance of forces briefly, the piston ring is lifted off the sliding surface and can no longer seal correctly. The constant repetition of the process leads to fluttering on the piston ring.

Reasons for radial ring flutter

- Worn piston rings (reduction in the radial wall thickness) and an associated loss of pressure force between the piston ring and cylinder wall, as well as reduced ring stiffness
- Out-of-true cylinder bores and an associated increased ingress of combustion pressure in the sealing gap between the piston ring sliding surface and ring gap
- Asymmetric piston wear pattern due to bent connecting rods: The ring follows a slightly oval shape due to the out-of-plumb positioning inside the cylinder bore. This means that a higher level of combustion gas enters the top land area and between the piston ring and cylinder wall on the cylinder side with less piston contact
- Excessive, crowned wear on the sliding surface of the piston ring due to excessive ring height clearance
- Damaged ring edges caused by incorrect honing (peak folding formation): The ring is torn open and frayed on the ring edges (mainly on simple cast rings without a surface coating), gas enters the sealing gap and lifts the piston ring off the sliding surface.



Fig. 2: Gas pressure on the piston ring sliding surface

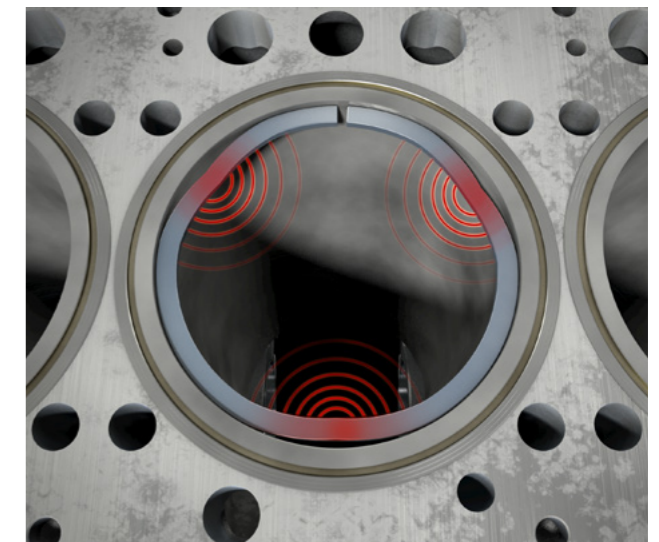

Fig. 3: Lifting of the piston ring from the sliding surface

2.7 LUBRICATION AND OIL CONSUMPTION

2.7.1 GENERAL

The piston on four-stroke engines is always lubricated with splash and centrifugal oil from the crankshaft. However, the crank webs of the crankshaft are usually not immersed in the crankcase sump. This would cause the oil to foam and result in loss of power. The oil required for lubricating the cylinder wall is released from the bearing positions on main and connecting rod bearings as intended. Because the crankshaft rotates, this oil is distributed in drop form over the entire crankcase and is thus also sprayed on the cylinder wall if the piston is in the upper cylinder area.

On engines subjected to a high level of stress or on engines where only small amounts of oil are released from the bearings, the lubrication of the cylinder wall is guaranteed by using hollow bored connecting rods, which also spray the cylinder wall on the piston pressure side (Fig. 1). For engines equipped with piston spray cooling for better heat dissipation from the pistons, these measures are not required.

The direct oil cooling means that enough oil runs back inside the piston, which lubricates the cylinder wall as it travels.

Depending on the engine speed, oil pressure and design features, the oil quantities in drop form on the cylinder wall must be scraped off and distributed by the oil control rings. To achieve an optimal lubricating effect with minimal oil consumption, the lubricating film on the cylinder wall must be no more than 1–3 µm thick. A thinner lubricating film causes mixed friction and high component wear. A thicker lubricating film usually results in higher oil consumption. The causes leading to an oil film that is either too thin or too thick are outlined in chapter 1.5.5 Crowned sliding surface shapes, among others.

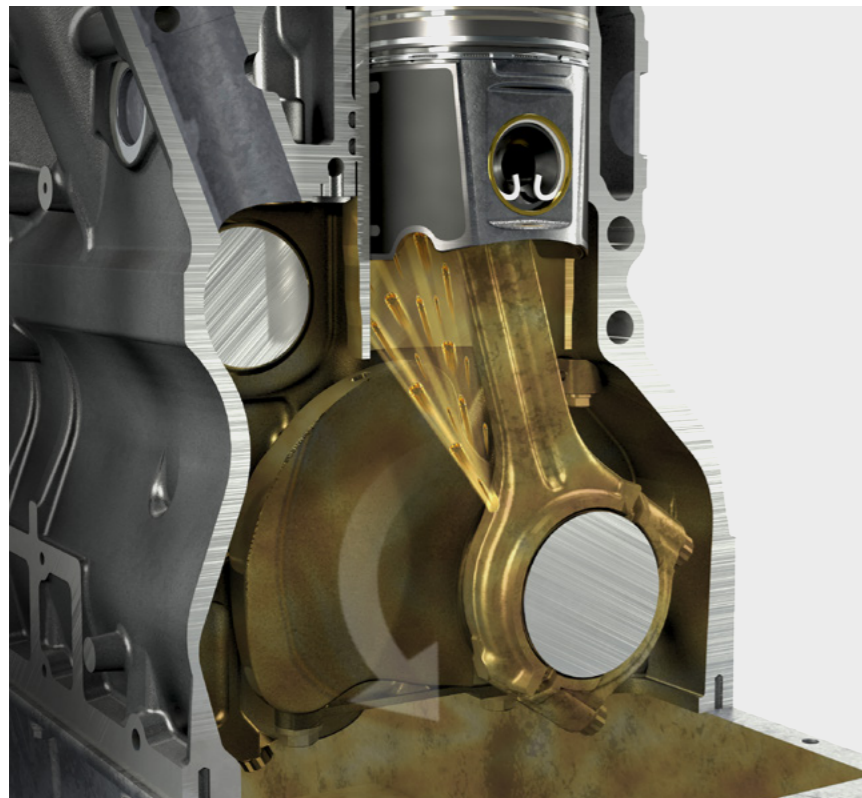

Fig. 1: Oil spray holes in the connecting rod ensure that the sliding surface is lubricated

2.7.2 ENGINE OIL

Engine oil is the most important component in the engine. If the components were not lubricated with oil and cooled, it would not be possible to run a combustion engine as we know and use them today. The oil separates the interacting sliding parts with a thin oil film and, through lubrication, prevents the metal friction and wear between the interacting sliding parts. The engine oil also has the task of transporting heat and dirt within the engine.

Important tasks of engine oil

- Lubrication (separation of the metal surfaces moving against each other)
- Cooling (heat dissipation)
- Removal of dirt
- Stability against shearing effects (e.g. caused by sharp piston ring edges)
- Sealing of the combustion chamber to the crankcase and the intake and exhaust gas ports via the valve guides to the valve train

- Integration of solid external substances, dust, abrasion and combustion products such as soot or ash
- Corrosion protection of the engine parts against aggressive combustion products through formation of protective layers on the metal surface
- Neutralisation of acidic combustion products through chemical conversion
- Transfer of forces in hydraulic chain tensioners and valve tappets
- Keeping the engine parts clean by removing carbon deposits and ageing products of the engine oil with oil-soluble soaps
- Protection from wear (the engine components moving against each other)
- Making undesired combustion products harmless





Engine oil consists of a base oil and additives. To improve the characteristics of the base oil, additives are added to the oil. The content of additives and their composition is derived from the requirements placed on the oil.

The additives cause or have an influence over

- Viscosity and flow properties
- Surface-active performance
- Neutralisation capacity
- Neutral behaviour towards sealing materials
- Low foaming tendency
- Long service life, long oil change intervals
- Low oil consumption
- Low fuel consumption
- Fuel compatibility
- Environmental safety

Engine oil is depleted through ageing and contamination. The additives in the oil are used up and aggressive combustion products and dirt contaminate the oil. The ageing of the oil is partly caused by high temperatures.

Engine oil consists of long-chain hydrocarbon molecules. The viscosity of the oil is determined by the length of the molecular chains. Long molecules have a higher viscosity. The long molecular chains are chopped into shorter pieces during engine operation due to shearing influences. This has a negative impact on the viscosity and the lubricating characteristics. In extreme situations, the oil is then less resistant and no longer able to guarantee the desired lubrication characteristics.

Carrying out a fine filtration of the engine oil via special filtration measures outside the engine to remove as many dirt particles as possible is futile. The oil itself becomes a problem and not the dirt transported along with it.

Note: In some countries, the oil is filtered through cloths and then resold.

The combustion process causes acids and other harmful substances to form, which decompose the oil gradually. A high influence of heat also causes some of the low-boiling oil components to vaporise, which also results in a change in the composition. The use of ultrafine filters, which promise life-long oil usage without the need for an oil change, is therefore questionable.

Oil still has to be topped up periodically and expensive additives also have to be added, because a natural oil consumption occurs with every engine and, sooner or later, there would otherwise be no oil left in the engine. So installing additional systems such as these would hardly be economically advantageous for the owner of the vehicle.

Summary

Both the base oil and the additives are used up over time, so that the oil has to be changed at regular intervals (oil change). During the oil change and the filter replacement, the harmful combustion products are removed from the engine and made harmless. The fresh oil lubricates and cleans more effectively and offers new reserves against all damaging influences the oil is subjected to.



2.7.3 GENERAL OIL CONSUMPTION

Experts refer to oil consumption as the quantity of oil that enters and is burned up in the combustion chamber. But not oil that runs through seals and drips on the outside of the engine. In this case, we talk about oil loss and not oil consumption.

The main causes of oil consumption are

- Faults on the turbocharger (faulty bearings, blocked oil return lines)
- Faults on mechanical fuel injection pumps (worn pump elements)
- Worn valve stem seals and valve guides
- Faults on the sealing system piston-piston ring-cylinder bore (see next chapter)

NOTE

Further information can be found in the brochure "Oil consumption and oil loss".

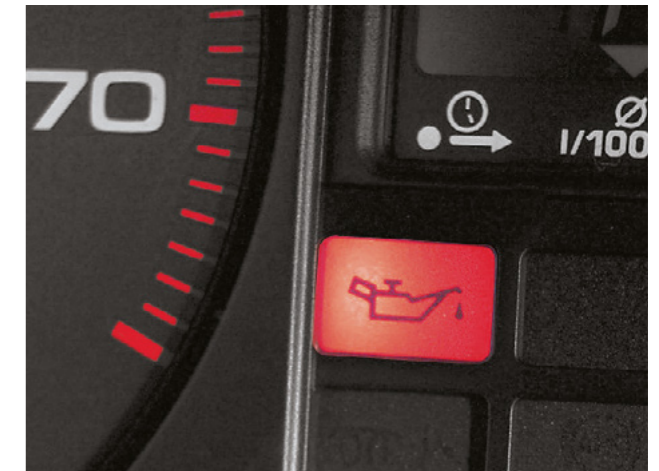

2.7.4 OIL CONSUMPTION THROUGH PISTON-PISTON RING-CYLINDER BORE

NORMAL OR DESIGN-RELATED OIL CONSUMPTION

Oil that passes by the piston-piston ring-cylinder bore from the crankcase into the combustion chamber is burnt and results in oil consumption. Due to the design of the combustion engine and the sealing system piston-piston ring-cylinder bore, a certain amount of "normal" oil consumption occurs naturally during engine operation.

The engine oil is present on the cylinder wall in the form of a thin oil film (approx. 1–3 µm thick) and is subjected to the hot combustion during the downstroke of the piston in the combustion cycle. The hot combustion gases cause vaporisation during each combustion cycle and the combustion of

small quantities of oil, which then become noticeable as oil consumption over a prolonged period. The change in movement of the piston in the upper top dead centre and the resulting inertial forces drive the oil off the piston rings. This quantity of oil is burnt during the combustion in the next combustion cycle.

INCREASED AND EXCESSIVE OIL CONSUMPTION

Excessive oil consumption caused solely by the sealing system piston-piston ring-cylinder bore can always be traced back to reasons for which the piston rings are not primarily responsible. Although the piston rings are involved, they are not the cause.

Reasons for increased oil consumption caused by poor sealing effect of the piston rings, include

- Worn rings (reduction in the radial and axial wall thicknesses)
- Incorrect honing
- Abrasive wear due to soiling (chapter 2.6.4 Dirt)
- Oval cylinders and/or out-of-true cylinders (see also chapter 2.3.5 Cylinder geometry and roundness)
- Worn pistons (ring grooves) due to dirt and long service life
- Worn cylinders (out-of-true, polished, distorted)
- Skewed pistons due to bent connecting rods (see chapter 2.6.1 Skewing of pistons)
- Wrong oil specification
- Used and outdated oil
- Mixed friction due to fuel flooding (see chapter 2.6.5 Fuel flooding)
- Ring flutter (see chapter 2.6.7 Ring flutter)
- Scratched sealing areas (bottom groove sides) due to incorrect cleaning of the ring grooves
- Rings sticking in the ring grooves due to dirt, carbon or bent rings (incorrect handling)
- Lack of groove base clearance due to incorrect rings or carbon deposits (incorrect oil specification)
- Incorrect ring assembly, incorrect ring heights, incorrect radial wall thickness, incorrect shape (rectangular ring in keystone groove and vice-versa)
- Incorrect installation of oil control rings (incorrect installation of the expander springs)

2.7.5 DEFINING OIL CONSUMPTION (COMPARISON AMOUNTS)

There are various ways of expressing levels of oil consumption. During engine test operation on a test rig, oil consumption is expressed as "grammes per kilowatt-hour". A good sealing system will achieve oil consumptions of 0.5 to 1 g/kWh. This method is not suitable for use in practice as oil consumption cannot be precisely defined in grammes, nor can performance be measured with the vehicle in operation.

For this reason, oil consumption is often measured in litres/1,000 km or as a percentage of fuel consumption. The latter is most commonly used to express measurements as it is more precise than litres per 1,000 km. The reason for this is that engines are also used when the vehicle is stationary, and will sometimes experience lengthy idling times (congestion, waiting at traffic lights, charging, running the air conditioning). Moreover, in some instances the engine may need to be used to operate auxiliary units, such as loading cranes or in pump operation, without the vehicle driving a single kilometre.

**2.7.6 WHEN IS AN ENGINE CONSUMING TOO MUCH OIL?**

In practice, opinions about the point at which oil consumption is excessive differ widely in different countries. A widely spread assumption or expectation is that an engine does not use or must not use any oil, but this is fundamentally wrong for the reasons outlined above.

Every engine manufacturer has guide values or limit values for oil consumption for each of its engines. If increased oil consumption is suspected, then the guide value or limit value for oil consumption specified by the relevant engine manufacturer must be obtained. Repair shop manuals and operating instructions often also provide information on the oil consumption of an engine.

If no exact oil consumption values are available from the engine manufacturer, an oil consumption of 0.25 % to 0.5 % based on the actual fuel consumption can be assumed. On small passenger car engines, this may be slightly less. In this case, the oil consumption is between 0.1 % and 0.5 % of the fuel consumption.

Diesel engines always use more engine oil than petrol engines. Engines with a turbocharger also need more oil than engines without a turbocharger due to lubrication of the turbocharger.

It is clear, however, that the oil consumption is lowest after the running-in phase and the consumption increases over the life of the engine. The minimum values therefore apply more for new engines and the maximum values apply for engines that have already exceeded 2/3 of their service life. Even on engines where only partial repairs have been carried out (e.g. replacement of the pistons or only the piston rings), it can not simply be assumed that the maximum value will not be exceeded. The opposite is often the case. All parts of an engine wear equally. If only 10 % of an engine is replaced, the maximum improvement it is possible to achieve in the best case scenario is just 10 %.

**EXAMPLE CALCULATION FOR UTILITY VEHICLES**

A utility vehicle consumes roughly 40 litres of fuel for 100 km travelled.

This can be extrapolated to 400 litres of fuel for 1000 km.

- 0.25 % of 400 litres of fuel equals 1 litre of oil consumption.
- 0.5 % of 400 litres of fuel equals 2 litre of oil consumption.

**EXAMPLE CALCULATION FOR PASSENGER CARS**

A passenger car consumes roughly 8 litres of fuel for 100 km travelled.

This amounts to 80 litres of fuel for 1000 km.

- 0.1 % of 80 litres of fuel equals 0.08 litre of oil consumption.
- 0.5 % of 80 litres of fuel equals 0.4 litre of oil consumption.

2.7.7 DEFINITION OF AND DEALING WITH OIL CONSUMPTION

FOR OIL CONSUMPTION, WE MUST DIFFERENTIATE BETWEEN DIFFERENT INFORMATION

NORMAL OIL CONSUMPTION

The oil consumption is within the limits specified by the manufacturer or within the values listed in the previous chapter. There is no fault or reason for complaint.

INCREASED OIL CONSUMPTION

On utility vehicles, the oil consumption is between double and triple the normal oil consumption. On passenger cars, it is 0.5 to 1 litres/1,000 km. The engine is running normally and is not necessarily showing signs of blue smoke from the exhaust system.

Occurrence

Vehicles that have already exceeded 2/3 of the normal service life. Also new, repaired and reconditioned engines that are still in the running-in phase. Engines that are operated in unfavourable conditions (hot ambient temperatures, frequent short-distance drives, idle mode, trailer operation, etc.).

Remedies

Not necessary or may not be necessary, but observation and regular oil level checks/top ups are required to ensure that the oil level does not sink below the minimum during operation. Where necessary, look in to what is causing the increased oil consumption. In addition to the engine itself, accessories such as turbochargers, mechanical fuel injection pumps and vacuum pumps are potential candidates, or an even distribution across all accessories. It may be possible to remedy the oil consumption through targeted repairs. If there is damage on one of the accessories, which is contributing significantly to the oil consumption, the oil consumption may also have increased erratically.

Jumps in the oil consumption of this kind are not expected as a result of normal wear on the components, however. Faults in the mixture formation/fuel injection, which make themselves felt in the black smoke from the exhaust system, also contribute significantly to the piston and cylinder wear, and thus also increased oil consumption, and should be remedied.

EXCESSIVE OIL CONSUMPTION

On passenger cars, the oil consumption is more than 1.5 litres, on heavy utility vehicles, it is more than 5 litres. The oil consumption can be seen on the oil dipstick, as well as visually in the form of blue smoke (particularly after an overrun condition). The quantity of topped up oil results in significant additional costs, which make a thorough inspection, repair and reconditioning of the unit necessary.

Occurrence

With completely worn engines and engines that have been reconditioned incorrectly or inadequately. With engine damage such as piston seizures, piston fractures, turbocharger damage or following a failure of other oil-lubricated accessories.



2.7.8 HOW TO CHECK OIL LEVEL AND OIL CONSUMPTION CORRECTLY

CHECKING THE OIL LEVEL

Reading errors often occur when checking the oil level, which lead to a misinterpretation of the actual oil consumption. The vehicle must be on even ground and the oil must be given five minutes after the engine is switched off to allow it to flow back into the oil pan and to drip off correctly. After withdrawing the dipstick, hold it vertical with the end pointing downwards so that the oil does not track back up the dipstick resulting in an incorrect reading.

If there really is insufficient oil, top up the oil slowly and in small quantities (in increments of 0.1 litres). If oil is topped up too quickly or if too much oil is added, the oil level will then be too high. If the crankshaft is dipped into the crankcase sump because the oil level is too high, the oil is stirred up, catapulted around and released in drop form in increased quantities for engine ventilation. Because the engine ventilation is connected in the intake air system, the oil is directed into the combustion chamber, where it is burnt.

When filling an engine after the oil change, the specified filling quantity is not topped up, but rather filling only takes place up to the maximum mark. Then run the engine until the oil pressure has built up. After switching off the engine, wait a couple of minutes for the oil to flow back into the oil pan. Having done this, check the oil level again and top up the oil level to the maximum mark.

MEASURING VEHICLE OIL CONSUMPTION

- Check the oil level using the proper method and top up to the maximum mark.
- Drive the vehicle for 1,000 km keeping a record of the fuel consumption.
- Check the oil level again after 1,000 km and top up to the maximum mark. The quantity added will be the oil consumption at 1,000 km.
- An alternative and more precise method is to view the topped up oil quantity in relation to the whole picture and compare it to the values stated above.
- Draining off and measuring the oil before and after the measuring run has not proven successful in practice. The measurement distortions due to the oil losses through collecting vessels and similar prevent a precise measurement.

TOP UP AMOUNTS

Particular care must be taken with the oil filling quantities listed in the handbook or operating instructions. Often, no differentiation is made between the first filling quantity (for dry, oil-free engines) and the change quantity (with/without oil filter replacement).

The fact is that, when the oil is changed, a certain amount of oil is left in the engine (adhering to pipes, channels, oil coolers, oil pumps, units and surfaces). If the oil quantity for initial filling is added when changing the oil, the oil level will be much too high. The reverse is also possible. The oil change quantity is specified too low. If the engine is started, there will be insufficient oil afterwards. If the oil is not topped up correctly and is no longer monitored, this is frequently misinterpreted as oil consumption. It is also important to ensure that the viscosity of the oil is correct. Oil with a low viscosity (thin) is used up more quickly than oil with a high viscosity. Only use the specified oil approved by the engine manufacturer.

2.7.9 OIL CONSUMPTION COMPLAINTS AND REMEDY

In the interest of fairness, complaints due to excessively high oil consumption should only be made if the vehicle has been maintained in accordance with the specifications and the inspection intervals have been complied with at all times. The correct spare parts and the specified engine oil must also have been used. Increased oil consumption does not occur suddenly. An engine continues to run without difficulty with a higher oil consumption. Maintenance transgressions and the resulting increased wear often only occur on older vehicles. The money saved on engine maintenance will ultimately still have to be paid out in increased oil consumption and premature repairs.

The success of repairs for remedying increased oil consumption depends largely on the time and material requirements. The vehicle owner or repair company determines themselves how good the repair result will be. But one thing is certain: Installing new piston rings alone will enable a worn engine to run for a while longer. But the oil consumption will not be improved.



KNOW-HOW TRANSFER

PROFESSIONAL KNOWLEDGE FROM THE EXPERTS

WORLDWIDE TRAININGS

Direct from the manufacturer

Each year, around 4,500 mechanics and engineers benefit from our training courses and seminars, which we hold on-site in locations across the world or in our training centres in Neuenstadt, Dormagen and Tamm (Germany).

TECHNICAL INFORMATION

From practical experience for practical use

Our Product Information and Service Information publications, technical brochures and posters keep you at the forefront of the latest technological developments.

TECHNICAL VIDEOS

Knowledge transfer via video

Our videos provide you with useful information on our products, such as hands-on fitting instructions and system descriptions.

 YouTube

PRODUCTS IN FOCUS ONLINE

Our solutions explained clearly

Interactive elements, animations and video clips provide interesting information about our products in and around the engine.

ONLINESHOP

Your direct access to our products

Order at any time. Quick availability check. Extensive product search by engine, vehicle, dimensions etc.

NEWS

Regular information via e-mail

Subscribe online to our free newsletter now and receive regular information about additions to the product range, technical publications and much more.

INDIVIDUAL INFORMATION

Especially for our customers

We provide extensive information and services relating to our wide range of services: e.g. personalised sales-promoting materials, sales support, technical support and much more.



TECHNIPEDIA

Technical information on all aspects of the engine

We share our know-how with you in our Technipedia. You can get professional knowledge direct from experts here.

MOTORSERVICE APP

Access technical know-how on the move

Here, you will find the latest information and services relating to our products quickly and easily.

SOCIAL MEDIA

Always up to date



HEADQUARTERS:

MS Motorservice International GmbH

Wilhelm-Maybach-Straße 14–18

74196 Neuenstadt, Germany

www.ms-motorservice.com



4 028977 630637

www.rheinmetall.com

© MS Motorservice International GmbH – 50 003 958-02 – EN – 10/18 (102018)